







CIRCUIT BREAKER 3VA2 IEC FRAME 160 BREAKING CAPACITY CLASS H ICU=85KA @ 415 V 3POLE, LINE PROTECTION ETU330, LIG, IN=160A OVERLOAD PROTECTION IR=63A ...160A SHORT CIRCUIT PROTECTION II=1,5...10 X IN GROUNDFAULTPROTECTION IG=0,2... 1 X IN, TG=0,1/0,3S BUSBAR CONNECTION SHUNT TRIP LEFT 208-277 V AC 50/60 HZ 1 AUXILIARY SWITCH 1 TRIP ALARM SWITCH



## Certificates

General Product Approval		EMC	Declaration of Conformity	Test Certificates
				
CCC	VDE		RCM	EG-Konf.
<a href="#">Typrüfbescheinigung/Werkszeugnis</a>				<a href="#">sonstig</a>
	ABS	LRS		

## Further information

Information- and Downloadcenter (Catalogs, Brochures,...)  
<http://www.siemens.com/lowvoltage/catalogs>

**Industry Mall (Online ordering system)**

<https://eb.automation.siemens.com/mall/en/WW/Catalog/Product/3VA2116-6HM32-0KG0>

**Service&Support (Manuals, Certificates, Characteristics, FAQs,...)**

<http://support.automation.siemens.com/WW/view/en/3VA2116-6HM32-0KG0/all>

**Image database (product images, 2D dimension drawings, 3D models, device circuit diagrams, ...)**

[http://www.automation.siemens.com/bilddb/cax\\_en.aspx?mlfb=3VA2116-6HM32-0KG0](http://www.automation.siemens.com/bilddb/cax_en.aspx?mlfb=3VA2116-6HM32-0KG0)

**CAX-Online-Generator**

<http://www.siemens.com/cax>

**Tender specifications**

<http://www.siemens.com/specifications>

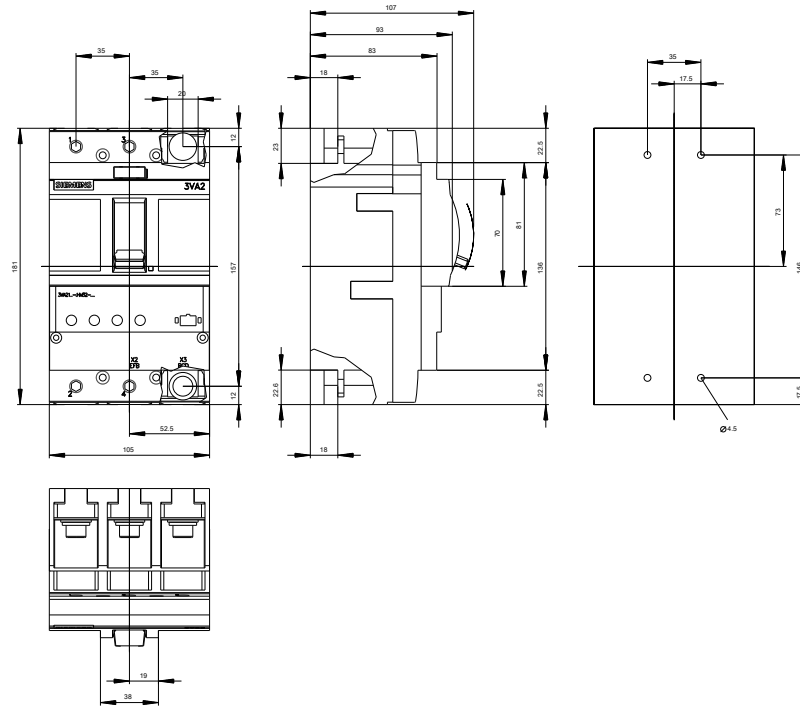

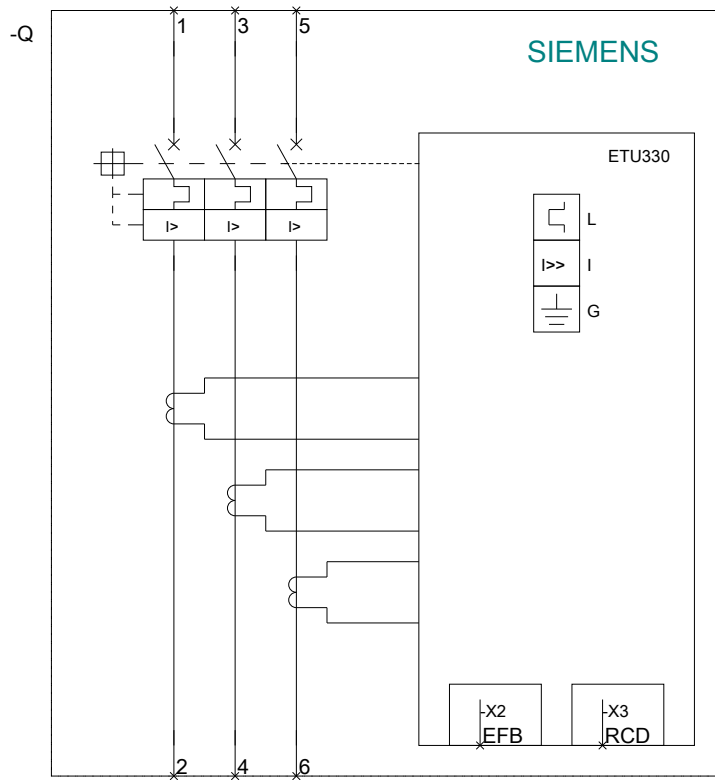

last modified:

11/01/2016