



CIRCUIT BREAKER 3VA2 IEC FRAME 100 BREAKING CAPACITY CLASS L ICU=150KA @ 415 V 4POLE, LINE PROTECTION ETU330, LIG, IN=63A OVERLOAD PROTECTION IR=25A ...63A SHORT CIRCUIT PROTECTION II=1,5...12 X IN NEUTRAL PROTECTION ADJUSTABLE(OFF,100%) GROUNDFAULTPROTECTION IG=0,25... 1 X IN, TG=0,1/0,3S CABLE CONNECTION

Model	
product brandname	SENTRON
Product designation	Molded case circuit breaker
Design of the product	Line protection
Type of load switch / according to UL 489 / Heating, Air Conditioning, and Refrigeration circuit breaker (HACR Type)	Yes
Design of the overcurrent release	ETU330
Protective function of the overcurrent release	LIG
Number of poles	4
General technical data	
Tension assignée d'isolement Ui	800 V
Max. rated operational voltage Ue with AC 50/60Hz	690 V
Active power loss / for rated value of the current / at AC / in hot operating state / per device	3 W
Active power loss / for rated value of the current / at AC / in hot operating state / per pole	1 W
Mechanical service life (switching cycles) / typical	20 000

Electrical endurance (switching cycles) / at AC-1 / at 380/415 V 50/60 Hz	12 000
Neutral conductors / upgradeable/retrofitable	No
Ground fault monitoring version	Summation current formation L + N conductor
Product function	
• communication function	No
• other measurement function	No
Net weight	3.13 kg

Electricity

Marking / according to UL 489 / 100%-rated breaker	No
Max. rated operational voltage of the size of the circuit-breaker	100 A
Courant permanent assigné Iu	63 A
Operating current	
• at 40 °C	63 A
• at 45 °C	63 A
• at 50 °C	63 A
• at 55 °C	63 A
• at 60 °C	63 A
• at 65 °C	63 A
• at 70 °C	63 A

Switching capacity according to IEC 60947

Switching capacity class of the circuit breaker	L
Maximum short-circuit current breaking capacity (Icu)	
• at 240 V	200 kA
• at 415 V	150 kA
• at 440 V	150 kA
• at 500 V	100 kA
• at 690 V	24 kA
Operational short-circuit current breaking capacity (Ics)	
• at 240 V	200 kA
• at 415 V	150 kA
• at 440 V	150 kA
• at 500 V	100 kA
• at 690 V	18 kA
Short-circuit current making capacity (Icm)	
• at 240 V	440 kA
• at 415 V	330 kA
• at 440 V	330 kA
• at 500 V	220 kA
• at 690 V	50 kA





Adjustable parameters	
Adjustable response value current / I _g min.	25 A
Adjustable response value current / I _g min.	63 A
Adjustable response value current / I _g min.	0.5
Adjustable response value current / I _g min.	17
Short-term delayed / tripping switchable / I _{2t} =ON/OFF	No
Adjustable response value current / I _i min.	95 A
Adjustable response value current / I _i max.	756 A
Design of the N-conductor protection	adjustable OFF; 100%
Ground fault protection can be switched ON/OFF	No
Ground fault protection / tripping switchable / I _{2t} =ON/OFF	Yes
Adjustable response value current / I _g min.	16 A
Adjustable response value current / I _g max.	63 A
Adjustable response value current / t _g min.	0.1 s
Adjustable response value current / I _g min.	0.3 s
Adjustable response value current / for G-tripping / with I _{2t} characteristic / min.	0 A
Adjustable response value current / for G-tripping / with I _{2t} characteristic / max.	0 A
Mechanical Design	
Height [in]	7.1 in
Height	181 mm
Width [in]	5.5 in
Width	140 mm
Depth [in]	4.2 in
Depth	107 mm
Connections	
Arrangement of electrical connectors / for main current circuit	Front terminal
Type of electrical connection / for main current circuit	Box terminal
Type of connectable conductor cross-section, round conductor terminal, stranded	1 x (6-120 mm ²)
Auxiliary circuit	
Number of CO contacts / for auxiliary contacts	0
Accessories	
Product extension / optional / motor drive	Yes
Environmental conditions	
Protection class IP / on the front	IP40
Ambient temperature	
• during operation / minimum	-25 °C



- during operation / maximum
- during storage / minimum
- during storage / maximum

70 °C
-40 °C
80 °C

Certificates

Equipment marking / acc. to DIN EN 81346-2	Q
Certificate of suitability / as approval for NAVAL (no combat vessels) / Supplement SB	No

General Product Approval	EMC	Declaration of Conformity	Test Certificates
 CCC	 VDE	 EAC	 RCM
 EG-Konf.			Typprüfbescheinigung/Werkszeugnis

Test Certificates	Shipping Approval	other
sonstig	 ABS	 LRS
		sonstig

Further information

Information- and Downloadcenter (Catalogs, Brochures,...)

<http://www.siemens.com/lowvoltage/catalogs>

Industry Mall (Online ordering system)

<https://eb.automation.siemens.com/mall/en/WW/Catalog/Product/3VA2063-8HM46-0AA0>

Service&Support (Manuals, Certificates, Characteristics, FAQs,...)

<http://support.automation.siemens.com/WW/view/en/3VA2063-8HM46-0AA0/all>

Image database (product images, 2D dimension drawings, 3D models, device circuit diagrams, ...)

http://www.automation.siemens.com/bilddb/cax_en.aspx?mlfb=3VA2063-8HM46-0AA0

CAX-Online-Generator

<http://www.siemens.com/cax>

Tender specifications

<http://www.siemens.com/specifications>

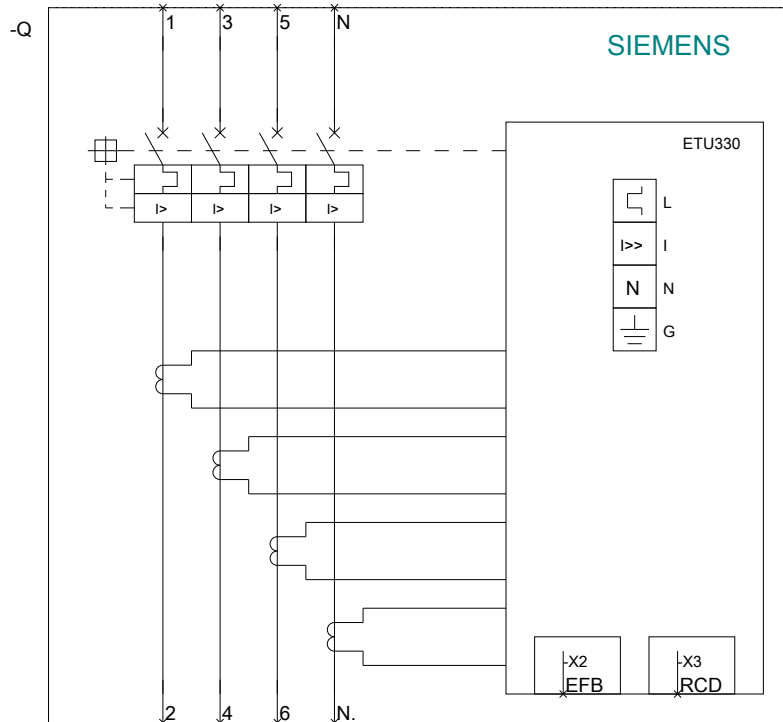
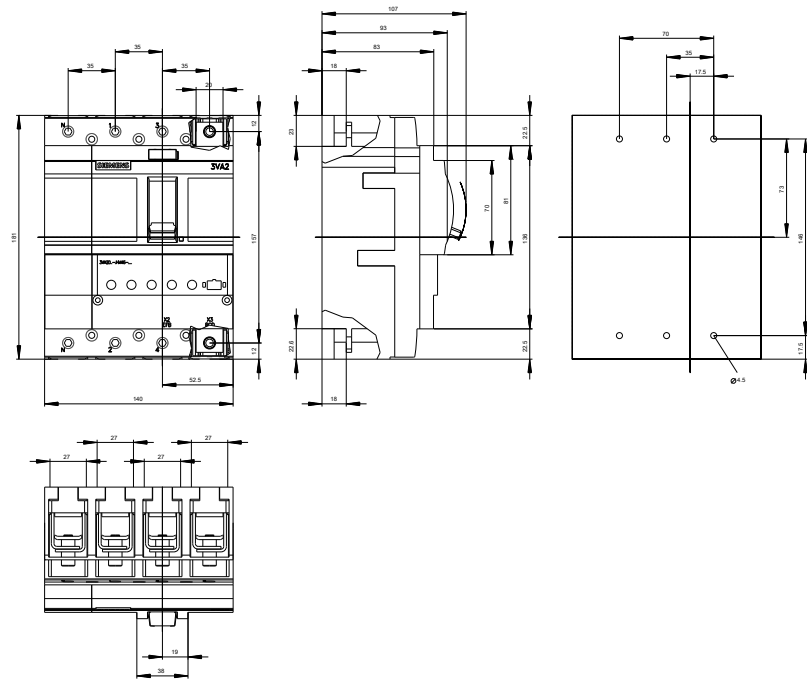

last modified:

10/29/2016