



CIRCUIT BREAKER 3VA2 IEC FRAME 400 BREAKING CAPACITY CLASS H ICU=85KA @ 415 V 4-POLE, LINE PROTECTION ETU560, LSIG, IN=250A OVERLOAD PROTECTION IR=100A ...250A SHORT CIRCUIT PROTECTION ISD=0,6..10X IN, II=1,5..12X IN NEUTRAL PROTECTION ADJUSTABLE (OFF, UPTO 160%) GROUND-FAULT, SWITCHABLE IG=0,2... 1 X IN, TG=0,05-0,8S BUSBAR CONNECTION

Model	
product brandname	SENTRON
Product designation	Molded case circuit breaker
Design of the product	Line protection
Type of load switch / according to UL 489 / Heating, Air Conditioning, and Refrigeration circuit breaker (HACR Type)	Yes
Design of the overcurrent release	ETU560
Protective function of the overcurrent release	LSIG
Number of poles	4
General technical data	
Tension assignée d'isolement Ui	800 V
Max. rated operational voltage Ue with AC 50/60Hz	690 V
Active power loss / for rated value of the current / at AC / in hot operating state / per device	37.5 W
Active power loss / for rated value of the current / at AC / in hot operating state / per pole	12.5 W
Mechanical service life (switching cycles) / typical	20 000

Electrical endurance (switching cycles) / at AC-1 / at 380/415 V 50/60 Hz	6 000
Neutral conductors / upgradeable/retrofitable	No
Ground fault monitoring version	Summation current formation L + N conductor
Product function	
• communication function	Yes
• other measurement function	No
Net weight	5.7 kg

### Electricity

Marking / according to UL 489 / 100%-rated breaker	No
Max. rated operational voltage of the size of the circuit-breaker	400 A
Courant permanent assigné Iu	250 A
Operating current	
• at 40 °C	250 A
• at 45 °C	250 A
• at 50 °C	250 A
• at 55 °C	242.5 A
• at 60 °C	237.5 A
• at 65 °C	230 A
• at 70 °C	220 A

### Switching capacity according to IEC 60947

Switching capacity class of the circuit breaker	H
Maximum short-circuit current breaking capacity (Icu)	
• at 240 V	110 kA
• at 415 V	85 kA
• at 690 V	5 kA
Operational short-circuit current breaking capacity (Ics)	
• at 240 V	110 kA
• at 415 V	85 kA
• at 690 V	5 kA
Short-circuit current making capacity (Icm)	
• at 240 V	242 kA
• at 415 V	187 kA
• at 690 V	7.5 kA

### Adjustable parameters

Adjustable response value current / I <sub>g</sub> min.	100 A
Adjustable response value current / I <sub>g</sub> min.	250 A
Adjustable response value current / I <sub>g</sub> min.	0.5
Adjustable response value current / I <sub>g</sub> min.	25
Adjustable response value current / I <sub>g</sub> min.	150 A

Adjustable response value current / I <sub>g</sub> min.	2 500 A
Short-term delayed / tripping switchable / I <sub>2t</sub> =ON/OFF	Yes
Adjustable response value current / I <sub>g</sub> min.	0.05 s
Adjustable response value current / I <sub>g</sub> min.	0.5 s
Adjustable response value current / I <sub>g</sub> min.	0.05 s
Adjustable response value current / I <sub>g</sub> min.	0.5 s
Adjustable response value current / I <sub>i</sub> min.	375 A
Adjustable response value current / I <sub>i</sub> max.	3 000 A
Design of the N-conductor protection	adjustable OFF; 20% bis 160%
Ground fault protection can be switched ON/OFF	Yes
Ground fault protection / tripping switchable / I <sub>2t</sub> =ON/OFF	Yes
Adjustable response value current / I <sub>g</sub> min.	50 A
Adjustable response value current / I <sub>g</sub> max.	250 A
Adjustable response value current / t <sub>g</sub> min.	0.05 s
Adjustable response value current / I <sub>g</sub> min.	0.8 s
Adjustable response value current / for G-tripping / with I <sub>2t</sub> characteristic / min.	0.2 A
Adjustable response value current / for G-tripping / with I <sub>2t</sub> characteristic / max.	1 A

#### Mechanical Design

Height [in]	9.8 in
Height	248 mm
Width [in]	7.2 in
Width	184 mm
Depth [in]	5.4 in
Depth	137 mm

#### Connections

Arrangement of electrical connectors / for main current circuit	Front terminal
Type of electrical connection / for main current circuit	Lug terminal

#### Auxiliary circuit

Number of CO contacts / for auxiliary contacts	0
--	---

#### Accessories

Product extension / optional / motor drive	Yes
--	-----

#### Environmental conditions





Protection class IP / on the front	IP40
Ambient temperature	
<ul style="list-style-type: none"> <li>• during operation / minimum</li> <li>• during operation / maximum</li> <li>• during storage / minimum</li> </ul>	<ul style="list-style-type: none"> <li>-25 °C</li> <li>70 °C</li> <li>-40 °C</li> </ul>





• during storage / maximum

80 °C

## Certificates

Equipment marking / acc. to DIN EN 81346-2	Q
Certificate of suitability / as approval for NAVAL (no combat vessels) / Supplement SB	No

General Product Approval	EMC	Declaration of Conformity	Test Certificates		
 CCC	 VDE	 EAC	 RCM	 EG-Konf.	<a href="#">Typprüfbescheinigung/Werkszeugnis</a>

Test Certificates	Shipping Approval				
<a href="#">sonstig</a>	 ABS	 BUREAU VERITAS	 GL	 LRS	 RMRS

other
<a href="#">sonstig</a>

## Further information

### Information- and Downloadcenter (Catalogs, Brochures,...)

<http://www.siemens.com/lowvoltage/catalogs>

### Industry Mall (Online ordering system)

<https://eb.automation.siemens.com/mall/en/WW/Catalog/Product/3VA2325-6JQ42-0AA0>

### Service&Support (Manuals, Certificates, Characteristics, FAQs,...)

<http://support.automation.siemens.com/WW/view/en/3VA2325-6JQ42-0AA0/all>

### Image database (product images, 2D dimension drawings, 3D models, device circuit diagrams, ...)

[http://www.automation.siemens.com/bilddb/cax\\_en.aspx?mfb=3VA2325-6JQ42-0AA0](http://www.automation.siemens.com/bilddb/cax_en.aspx?mfb=3VA2325-6JQ42-0AA0)

### CAX-Online-Generator

<http://www.siemens.com/cax>

### Tender specifications

<http://www.siemens.com/specifications>

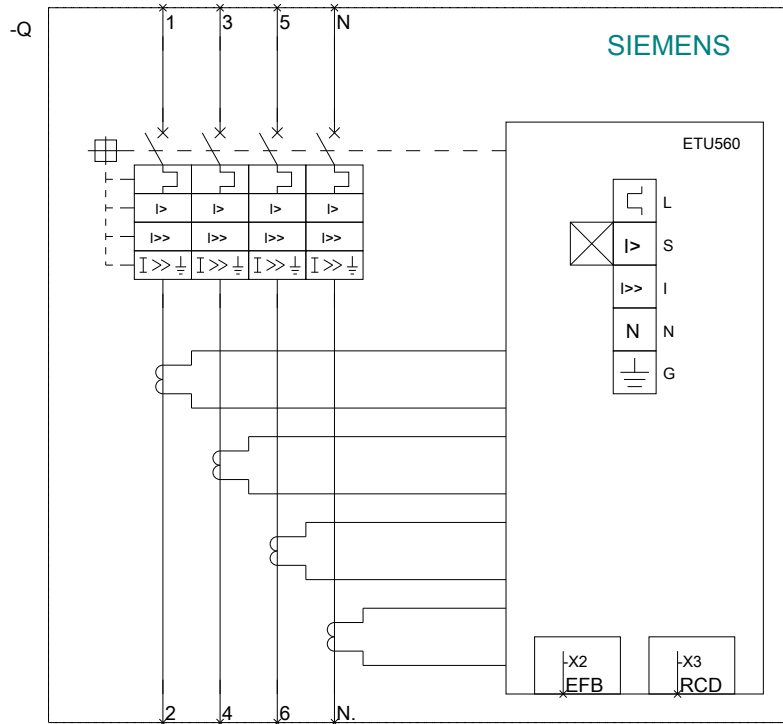
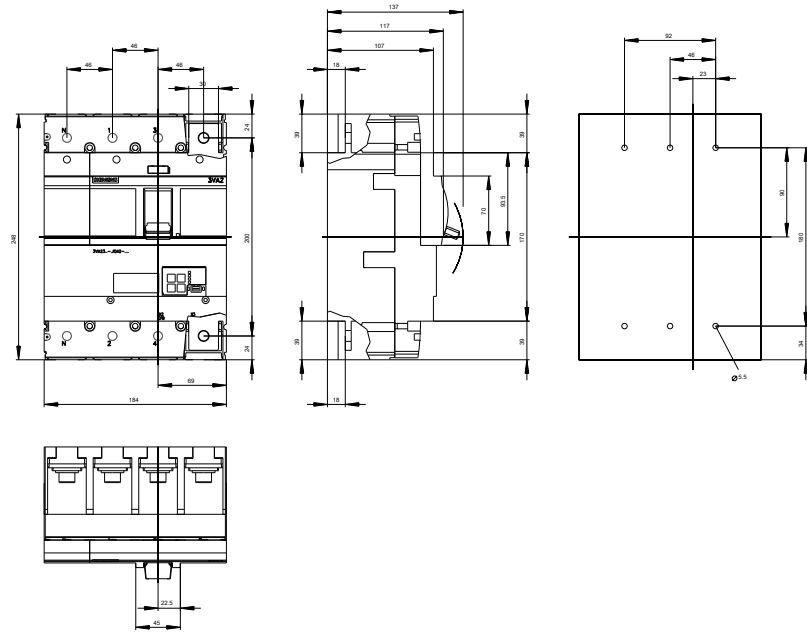

**last modified:**

10/29/2016