













CIRCUIT BREAKER 3VA2 IEC FRAME 400 BREAKING CAPACITY CLASS M ICU=55KA @ 415 V 3-POLE, LINE PROTECTION ETU320, LI, IN=400A OVERLOAD PROTECTION IR=160A ...400A SHORT CIRCUIT PROTECTION II=1,5...10 X IN BUSBAR CONNECTION UNDERVOLTAGE RELEASE 208-230 V AC 50/60 HZ 1 AUXILIARY SWITCH 1 TRIP ALARM SWITCH

Certificates

General Product Approval			EMC	Declaration of Conformity	Test Certificates
 CCC	 VDE		 RCM	 EG-Konf.	sonstig

Test Certificates	Shipping Approval				
Typprüfbescheinigung/Werkszeugnis	 ABS	 BUREAU VERITAS	 GL	 LRS	 RMRS

other
sonstig

Further information

Information- and Downloadcenter (Catalogs, Brochures,...)

<http://www.siemens.com/lowvoltage/catalogs>

Industry Mall (Online ordering system)

<https://eb.automation.siemens.com/mall/en/WW/Catalog/Product/3VA2340-5HL32-0DF0>

Service&Support (Manuals, Certificates, Characteristics, FAQs,...)

<http://support.automation.siemens.com/WW/view/en/3VA2340-5HL32-0DF0/all>

Image database (product images, 2D dimension drawings, 3D models, device circuit diagrams, ...)

http://www.automation.siemens.com/bilddb/cax_en.aspx?mfb=3VA2340-5HL32-0DF0

CAX-Online-Generator

<http://www.siemens.com/cax>

Tender specifications

<http://www.siemens.com/specifications>

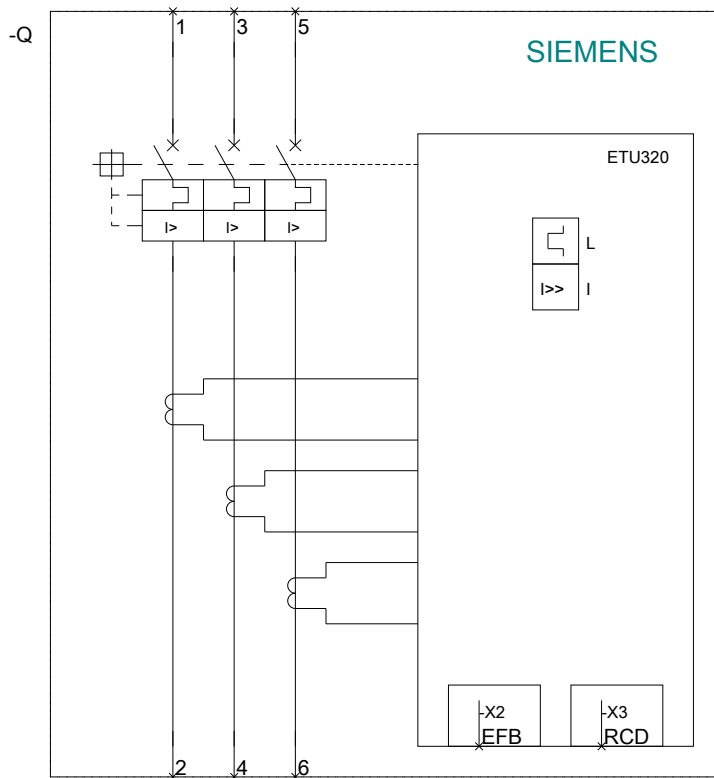
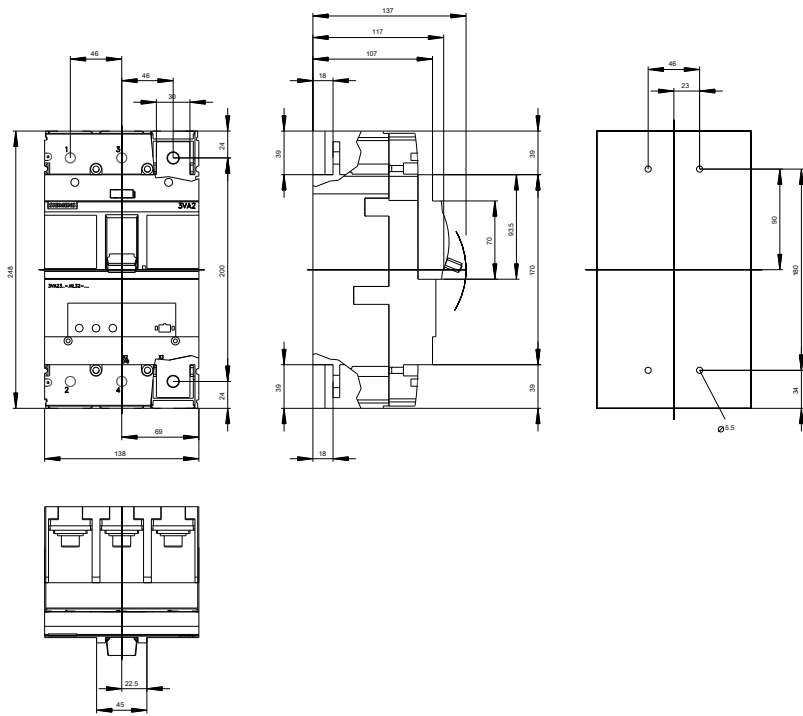

last modified:

11/01/2016