



CIRCUIT BREAKER 3VA2 IEC FRAME 400 BREAKING CAPACITY CLASS M ICU=55KA @ 415 V 4-POLE, LINE PROTECTION ETU320, LI, IN=400A OVERLOAD PROTECTION IR=160A ...400A SHORT CIRCUIT PROTECTION II=1,5... 10 X IN NEUTRAL PROTECTION ADJUSTABLE(OFF,50%,100%) BUSBAR CONNECTION UNDERVOLTAGE RELEASE (UVR) 24 V DC 2 AUXILIARY SWITCH HQ

Model	
product brandname	SENTRON
Product designation	Molded case circuit breaker
Design of the product	Line protection
Design of the overcurrent release	ETU320
Protective function of the overcurrent release	LI
Number of poles	4
Design of the auxiliary release	Undervoltage release (UVR)
Design of the auxiliary switch	2 auxiliary switches HQ

General technical data	
Tension assignée d'isolement Ui	800 V
Max. rated operational voltage Ue with AC 50/60Hz	690 V
Active power loss / for rated value of the current / at AC / in hot operating state / per device	98.5 W
Active power loss / for rated value of the current / at AC / in hot operating state / per pole	32 W
Mechanical service life (switching cycles) / typical	15 000
Electrical endurance (switching cycles) / at AC-1 / at 380/415 V 50/60 Hz	6 000

Neutral conductors / upgradeable/retrofitable	No
Ground fault monitoring version	Without
Product function	
• communication function	No
• Phase failure detection	No
• other measurement function	No
Net weight	4.8 kg

Electricity

Max. rated operational voltage of the size of the circuit-breaker	400 A
Courant permanent assigné Iu	400 A
Operating current	
• at 40 °C	400 A
• at 45 °C	400 A
• at 50 °C	400 A
• at 55 °C	385 A
• at 60 °C	370 A
• at 65 °C	355 A
• at 70 °C	340 A

Switching capacity according to IEC 60947

Switching capacity class of the circuit breaker	M
Maximum short-circuit current breaking capacity (Icu)	
• at 240 V	85 kA
• at 415 V	55 kA
• at 440 V	55 kA
• at 500 V	36 kA
• at 690 V	10 kA
Operational short-circuit current breaking capacity (Ics)	
• at 240 V	85 kA
• at 415 V	55 kA
• at 440 V	55 kA
• at 500 V	36 kA
• at 690 V	10 kA
Short-circuit current making capacity (Icm)	
• at 240 V	187 kA
• at 415 V	121 kA
• at 440 V	121 kA
• at 500 V	75.6 kA
• at 690 V	17 kA

Adjustable parameters

Adjustable response value current / I _g min.	160 A
Adjustable response value current / I _g min.	400 A
Adjustable response value current / I _g min.	0.5
Adjustable response value current / I _g min.	17
Short-term delayed / tripping switchable / I _{2t} =ON/OFF	No
Adjustable response value current / I _i min.	600 A
Adjustable response value current / I _i max.	4 000 A

Mechanical Design

Height	248 mm
Width	184 mm
Depth	110 mm

Connections

Arrangement of electrical connectors / for main current circuit	Front terminal
Type of electrical connection / for main current circuit	Lug terminal
Type of connectable conductor cross-section, connection screw, width x thickness , min.	20 x 1
Type of connectable conductor cross-section, connection screw, width x thickness , max.	35 x 10

Auxiliary circuit

Product component	
<ul style="list-style-type: none"> • undervoltage release 	Yes
<ul style="list-style-type: none"> • Voltage trigger 	No
<ul style="list-style-type: none"> • undervoltage release with leading contact 	No
<ul style="list-style-type: none"> • Trip indicator 	No
Number of CO contacts / for auxiliary contacts	2





Accessories

Product extension / optional / motor drive	Yes
Manufacturer's article number	
<ul style="list-style-type: none"> • of the supplied basic switch 	3VA2340-5HL42-0AA0
<ul style="list-style-type: none"> • of the integrated auxiliary switch/alarm switch 	3VA9988-0AA12
<ul style="list-style-type: none"> • of the integrated auxiliary trip 	3VA9608-0BB11





Environmental conditions

Protection class IP / on the front	IP40
Ambient temperature	
<ul style="list-style-type: none"> • during operation / minimum 	-25 °C
<ul style="list-style-type: none"> • during operation / maximum 	70 °C
<ul style="list-style-type: none"> • during storage / minimum 	-40 °C
<ul style="list-style-type: none"> • during storage / maximum 	80 °C

Certificates

General Product Approval		EMC	Declaration of Conformity	Test Certificates
 CCC	 VDE		 RCM	 EG-Konf.

[sonstig](#)

Test Certificates	Shipping Approval				
Typprüfbescheinigung/Werkszeugnis	 ABS	 BUREAU VERITAS	 GL	 LRS	 RMRS

other
sonstig

Further information

Information- and Downloadcenter (Catalogs, Brochures,...)

<http://www.siemens.com/lowvoltage/catalogs>

Industry Mall (Online ordering system)

<https://eb.automation.siemens.com/mall/en/WW/Catalog/Product/3VA2340-5HL42-0BC0>

Service&Support (Manuals, Certificates, Characteristics, FAQs,...)

<http://support.automation.siemens.com/WW/view/en/3VA2340-5HL42-0BC0/all>

Image database (product images, 2D dimension drawings, 3D models, device circuit diagrams, ...)

http://www.automation.siemens.com/bilddb/cax_en.aspx?mlfb=3VA2340-5HL42-0BC0

CAX-Online-Generator

<http://www.siemens.com/cax>

Tender specifications

<http://www.siemens.com/specifications>

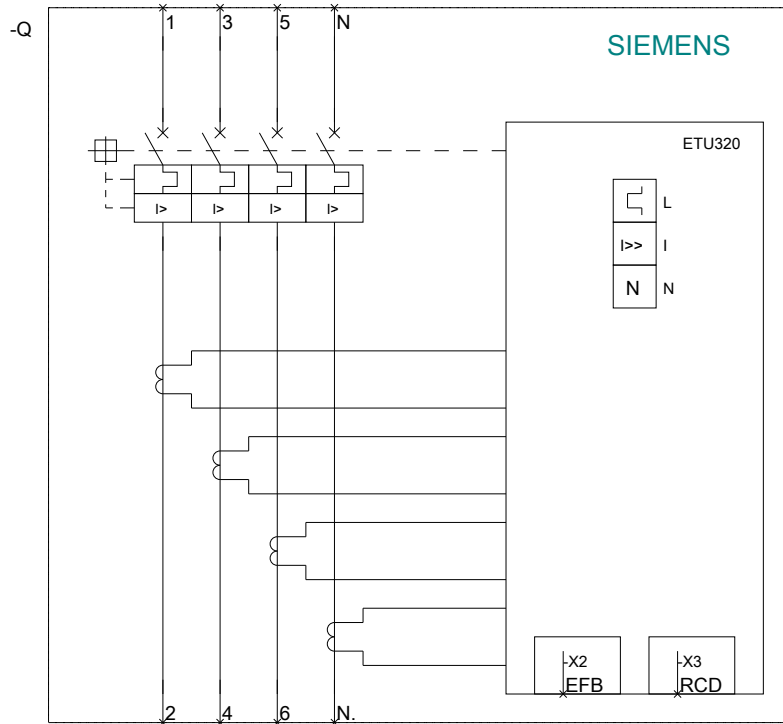
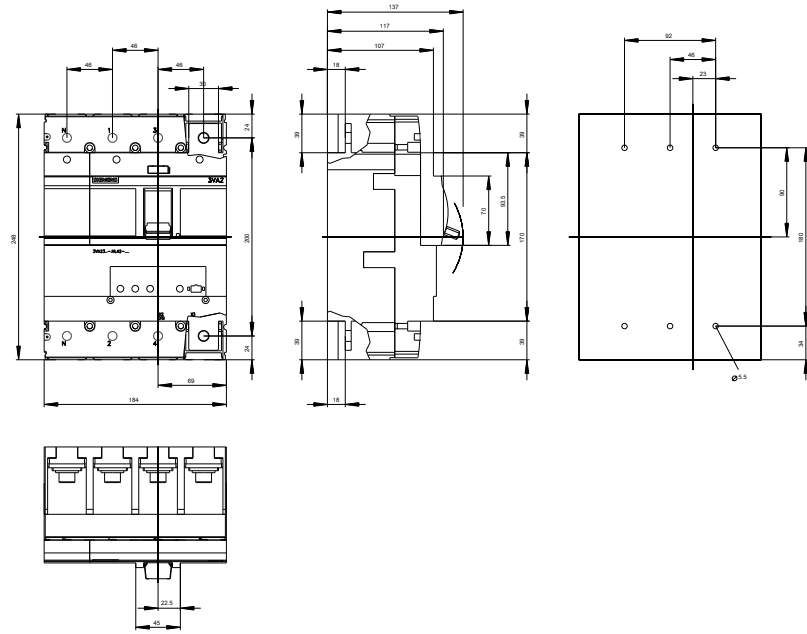

last modified:

10/29/2016