



CIRCUIT BREAKER 3VA2 IEC FRAME 400 BREAKING CAPACITY CLASS C ICU=110KA @ 415 V 4-POLE, LINE PROTECTION ETU330, LIG, IN=400A OVERLOAD PROTECTION IR=160A ...400A SHORT CIRCUIT PROTECTION II=1,5...10 X IN NEUTRAL PROTECTION ADJUSTABLE(OFF,50%,100%) GROUND-FAULT-PROTECTION IG=0,2... 1 X IN, TG=0,1/0,3S BUSBAR CONNECTION

Model	
product brandname	SENTRON
Product designation	Molded case circuit breaker
Design of the product	Line protection
Type of load switch / according to UL 489 / Heating, Air Conditioning, and Refrigeration circuit breaker (HACR Type)	Yes
Design of the overcurrent release	ETU330
Protective function of the overcurrent release	LIG
Number of poles	4
General technical data	
Tension assignée d'isolement Ui	800 V
Max. rated operational voltage Ue with AC 50/60Hz	690 V
Active power loss / for rated value of the current / at AC / in hot operating state / per device	96 W
Active power loss / for rated value of the current / at AC / in hot operating state / per pole	32 W
Mechanical service life (switching cycles) / typical	20 000

Electrical endurance (switching cycles) / at AC-1 / at 380/415 V 50/60 Hz	6 000
Neutral conductors / upgradeable/retrofitable	No
Ground fault monitoring version	Summation current formation L + N conductor
Product function	
• communication function	No
• other measurement function	No
Net weight	5.7 kg

Electricity

Marking / according to UL 489 / 100%-rated breaker	No
Max. rated operational voltage of the size of the circuit-breaker	400 A
Courant permanent assigné Iu	400 A
Operating current	
• at 40 °C	400 A
• at 45 °C	400 A
• at 50 °C	400 A
• at 55 °C	385 A
• at 60 °C	370 A
• at 65 °C	355 A
• at 70 °C	340 A

Switching capacity according to IEC 60947

Switching capacity class of the circuit breaker	C
Maximum short-circuit current breaking capacity (Icu)	
• at 240 V	150 kA
• at 415 V	110 kA
• at 440 V	110 kA
• at 500 V	85 kA
• at 690 V	5 kA
Operational short-circuit current breaking capacity (Ics)	
• at 240 V	150 kA
• at 415 V	110 kA
• at 690 V	5 kA
Short-circuit current making capacity (Icm)	
• at 240 V	330 kA
• at 415 V	242 kA
• at 440 V	242 kA
• at 500 V	187 kA
• at 690 V	7.5 kA

Adjustable parameters

Adjustable response value current / I _g min.	160 A
Adjustable response value current / I _g min.	400 A
Adjustable response value current / I _g min.	0.5
Adjustable response value current / I _g min.	17
Short-term delayed / tripping switchable / I _{2t} =ON/OFF	No
Adjustable response value current / I _i min.	600 A
Adjustable response value current / I _i max.	4 000 A
Design of the N-conductor protection	adjustable OFF; 50%; 100%
Ground fault protection can be switched ON/OFF	No
Ground fault protection / tripping switchable / I _{2t} =ON/OFF	Yes
Adjustable response value current / I _g min.	80 A
Adjustable response value current / I _g max.	400 A
Adjustable response value current / t _g min.	0.1 s
Adjustable response value current / I _g min.	0.3 s
Adjustable response value current / for G-tripping / with I _{2t} characteristic / min.	0 A
Adjustable response value current / for G-tripping / with I _{2t} characteristic / max.	0 A

Mechanical Design

Height [in]	9.8 in
Height	248 mm
Width [in]	7.2 in
Width	184 mm
Depth [in]	5.4 in
Depth	137 mm

Connections

Arrangement of electrical connectors / for main current circuit	Front terminal
Type of electrical connection / for main current circuit	Lug terminal

Auxiliary circuit

Number of CO contacts / for auxiliary contacts	0
--	---

Accessories





Product extension / optional / motor drive	Yes
--	-----





Environmental conditions

Protection class IP / on the front	IP40
Ambient temperature	
<ul style="list-style-type: none"> • during operation / minimum • during operation / maximum • during storage / minimum • during storage / maximum 	<ul style="list-style-type: none"> -25 °C 70 °C -40 °C 80 °C

Certificates

Equipment marking / acc. to DIN EN 81346-2	Q
Certificate of suitability / as approval for NAVAL (no combat vessels) / Supplement SB	No

General Product Approval	EMC	Declaration of Conformity	Test Certificates		
 CCC	 VDE	 EAC	 RCM	 EG-Konf.	Typprüfbescheinigung/Werkszeugnis

Test Certificates	Shipping Approval				
sonstig	 ABS	 BUREAU VERITAS	 GL	 LRS	 RMRS

other
sonstig

Further information

Information- and Downloadcenter (Catalogs, Brochures,...)

<http://www.siemens.com/lowvoltage/catalogs>

Industry Mall (Online ordering system)

<https://eb.automation.siemens.com/mall/en/WW/Catalog/Product/3VA2340-7HM42-0AA0>

Service&Support (Manuals, Certificates, Characteristics, FAQs,...)

<http://support.automation.siemens.com/WW/view/en/3VA2340-7HM42-0AA0/all>

Image database (product images, 2D dimension drawings, 3D models, device circuit diagrams, ...)

http://www.automation.siemens.com/bilddb/cax_en.aspx?mlfb=3VA2340-7HM42-0AA0

CAX-Online-Generator

<http://www.siemens.com/cax>

Tender specifications

<http://www.siemens.com/specifications>

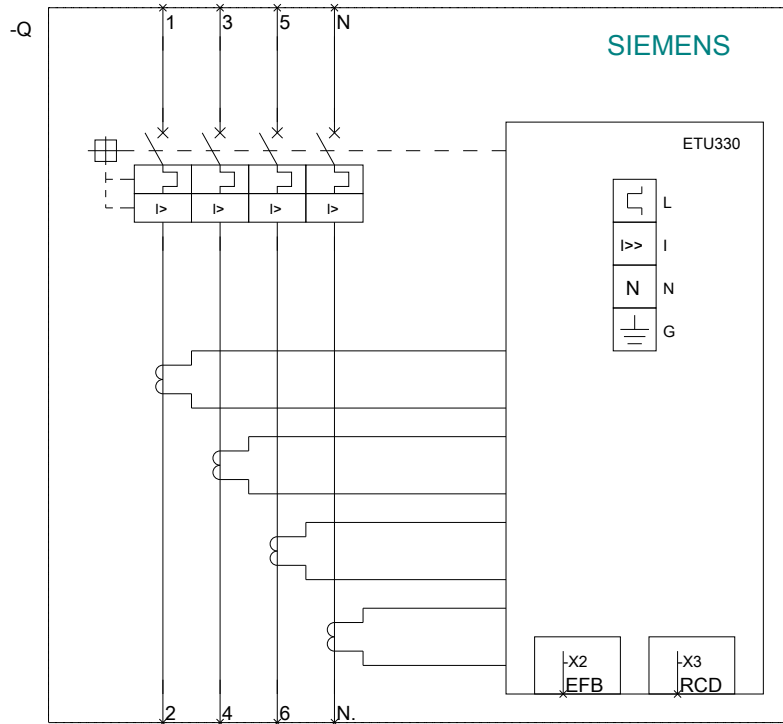
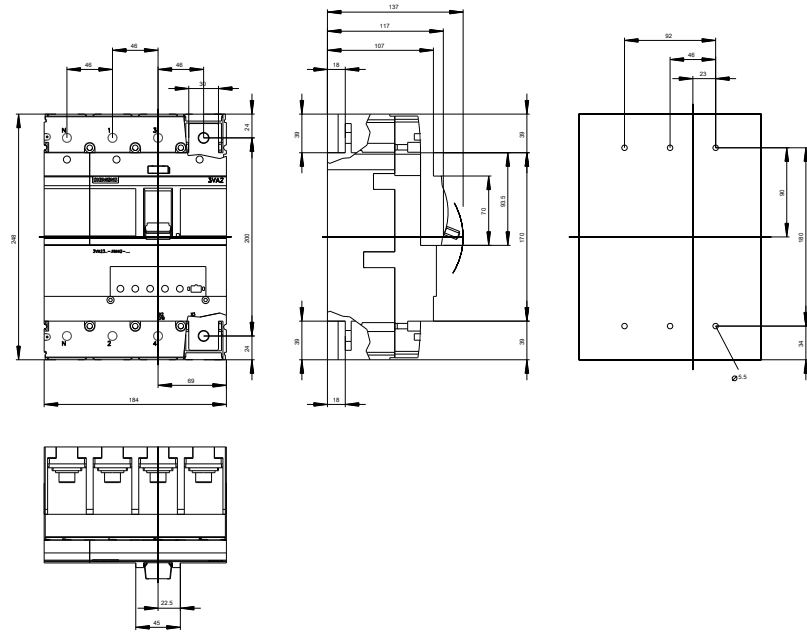

last modified:

10/29/2016