

# E12520

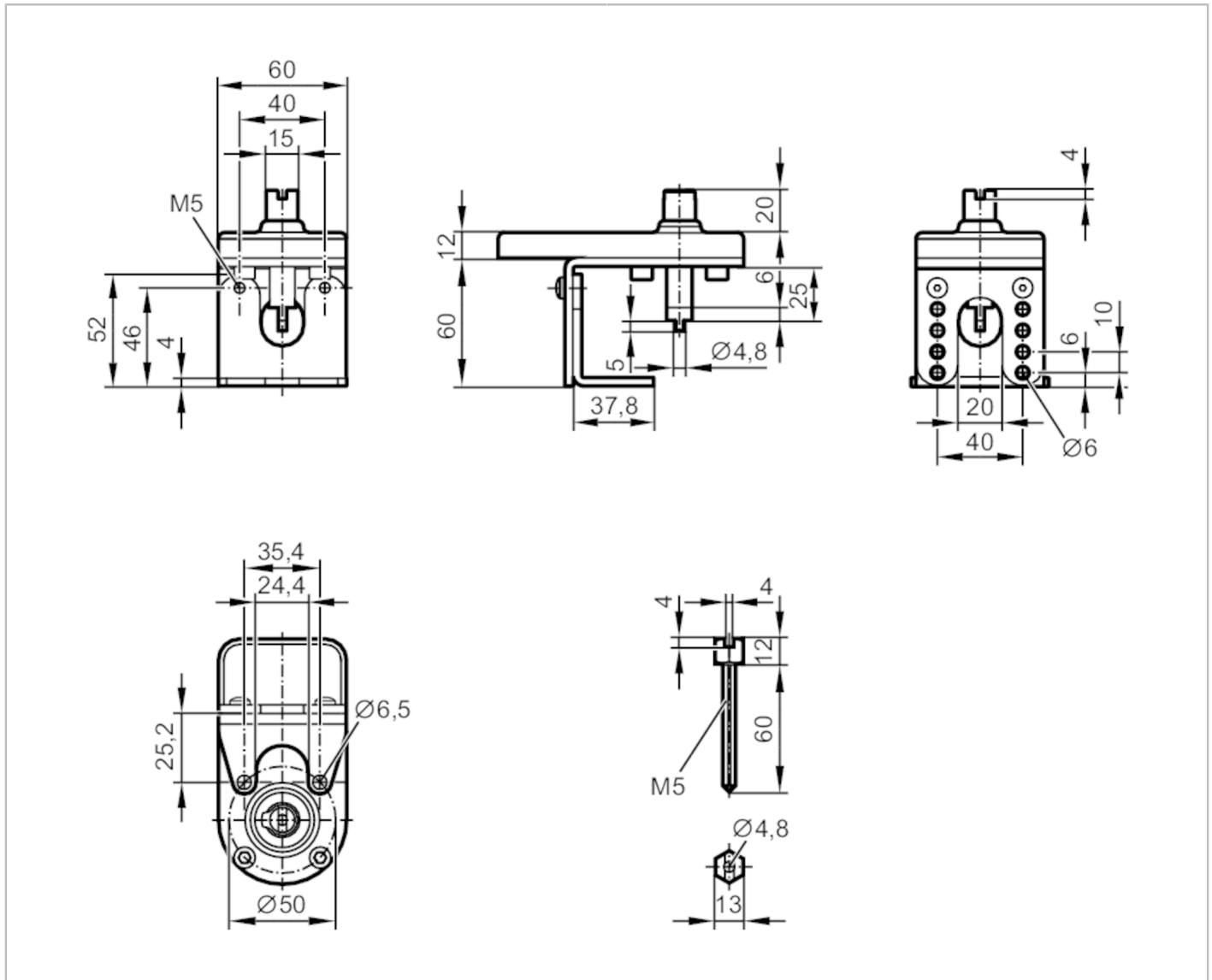

## Mounting set for manual valves and ball valves

MOUNTING KIT FOR MANUAL VALVES F05/M5



### Operating conditions

Ambient temperature [°C] -30...80

### Mechanical data

Weight [g] 471.2

Top flange diameter [mm] 50

ISO top flange type F05

Shaft extension M5

Materials Mounting plate: plastics; metal parts: stainless steel (1.4301 / 304)

### Remarks

Pack quantity 1 pcs.