

OY289S

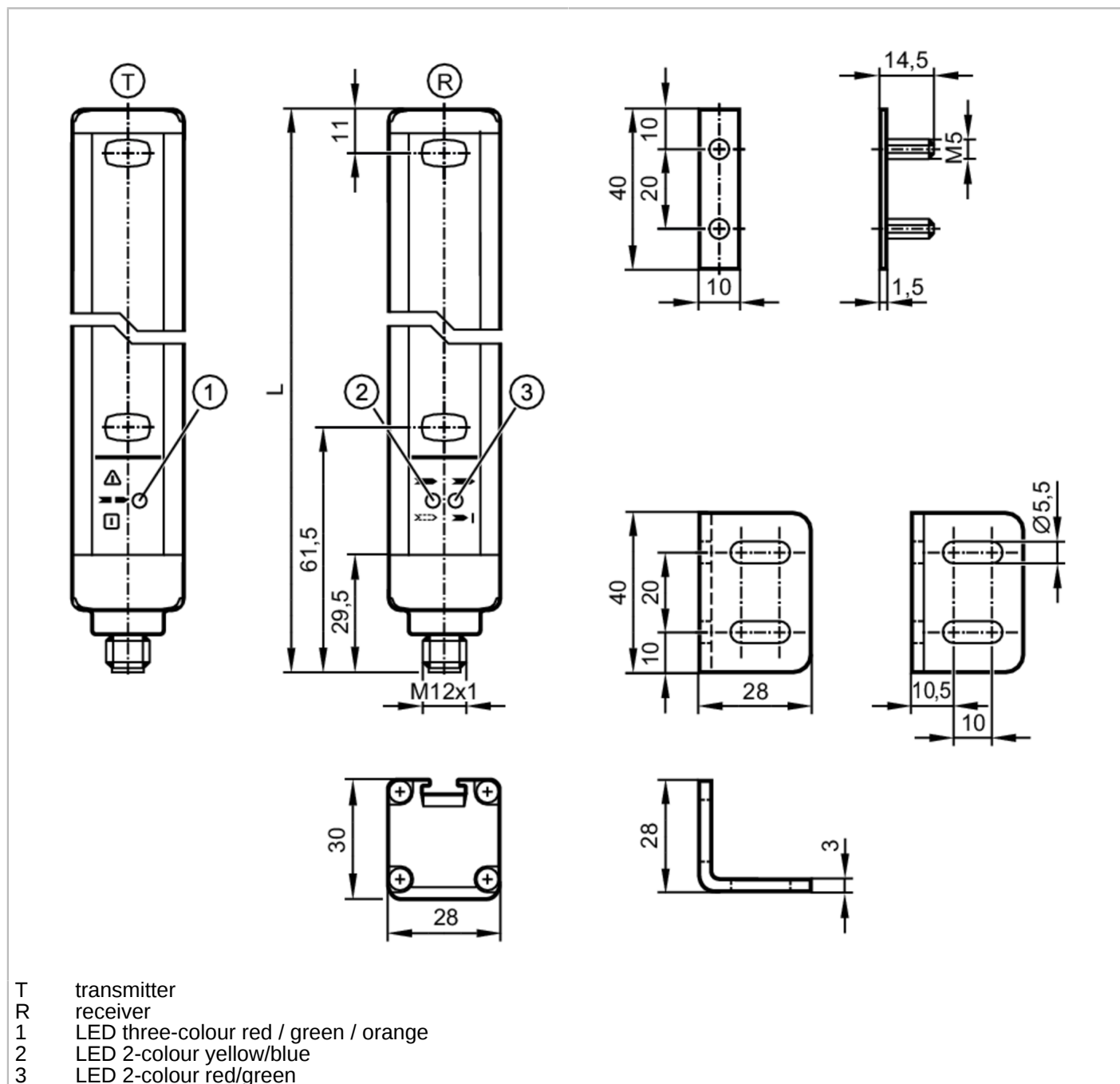

Safety light curtain

OYA1360-50-4-20-P-1



Application

Protective function

access prevention bodies or parts of bodies



Safety light curtain

OYA1360-50-4-20-P-1

Electrical data		
Operating voltage tolerance	[%]	20
Operating voltage	[V]	24 DC
Protection class		III
Reverse polarity protection		yes
Power-on delay time	[s]	< 2
Type of light		infrared light
Wave length	[nm]	950
receiver		
Current consumption	[mA]	83
transmitter		
Current consumption	[mA]	42
Outputs		
Electrical design		PNP
Number of OSSD outputs		2
Max. current load per OSSD output	[mA]	400; (24 V)
Short-circuit protection		yes
Detection zone		
Protected area height	[mm]	1360
Resolution (detection capacity d)	[mm]	50
Protection area width (low light intensity)	[m]	0...10
Protection area width (high light intensity)	[m]	3...20
Response times		
Response time	[ms]	6.5
Operating conditions		
Applications		class C to EN 60654-1 weatherproof application
Ambient temperature	[°C]	-10...55
Max. relative air humidity	[%]	95
Protection		IP 65; IP 67
Tests / approvals		
EMC		IEC 61496-1
Shock resistance		IEC 61496-1
Vibration resistance		IEC 61496-1
Safety classification		
ISO 13849-1		category: 4, PL: e
IEC 61508		SIL 3
IEC 62061		SILCL 3
Mission time TM	[h]	175200
Safety-related reliability PFHD	[1/h]	1.4E-08

OY289S



Safety light curtain

OYA1360-50-4-20-P-1

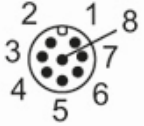
Mechanical data	
Weight [g]	4705
Dimensions [mm]	1413 x 28 x 30
Materials	housing: aluminium; front lens: PC
Length L [mm]	1413
Displays / operating elements	
Display	LED, yellow
	LED, green
	LED, red
	LED, blue
	LED, orange
Accessories	
Accessories (supplied)	mounting bracket: 6
	slot nuts: 6
	Nuts
Remarks	
Notes	For 8-pole sockets the core colours are not standardised.; Please note the wiring of the sensor and the sockets (see data sheet).
Pack quantity	1 pcs.
Electrical connection - receiver	
Connector: 1 x M12; Maximum cable length: 100 m; for wire cross-section 0.34 mm ²	
	

OY289S



Safety light curtain

OYA1360-50-4-20-P-1

Connection



Electrical connection - transmitter

Connector: 1 x M12

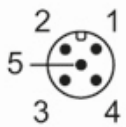

OY289S



Safety light curtain

OYA1360-50-4-20-P-1

Connection

