

EVT284

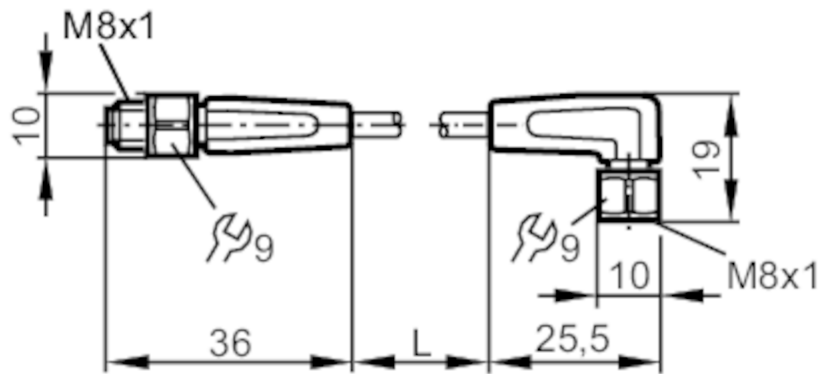

Connection cable

VDOAF040VAS00,6E03STGF030VAS



Application

Application	hygienic and wet areas in the food industry
Free from silicone	yes

Electrical data

Operating voltage	[V]	< 50 AC / < 60 DC
Protection class		III
Max. current load total	[A]	3

Operating conditions

Ambient temperature	[°C]	-25...80
Note on ambient temperature		cULus: ...50
Ambient temperature (moving)	[°C]	5...80
Note on ambient temperature (moving)		cULus: ...50
Protection		IP 65; IP 67; IP 68; IP 69K

EVT284



Connection cable

VDOAF040VAS00,6E03STGF030VAS

Mechanical data		
Weight [g]	39.5	
Dimensions [mm]	10 x 10 x 36	
Materials	housing: PVC orange; Sealing: EPDM	
Material nut	stainless steel (1.4404 / 316L) / stainless steel (1.4404 / 316L)	
Drag chain suitability	bending radius for flexible use	min. 10 x cable diameter
	travel speed	max. 3.3 m/s for a horizontal travel length of 5 m and max. acceleration of 5 m/s ²
	bending cycles	> 1 Mio.
	torsional strain	± 180 °/m
Drag chain suitability	yes	

Remarks	
Pack quantity	1 pcs.

Electrical connection	
Cable: 0.6 m, PVC, orange, Ø 4.9 mm; 3 x 0.34 mm ² (42 x Ø 0.1 mm)	

Electrical connection - socket	
Connector: 1 x M8, angled; Locking: stainless steel (1.4404 / 316L); Contacts: gold-plated; Tightening torque: 0.3...0.5 Nm	



Electrical connection - plug	
Connector: 1 x M8, straight; Locking: stainless steel (1.4404 / 316L); Contacts: gold-plated; Tightening torque: 0.3...0.5 Nm	



EVT284



Connection cable

VDOAF040VAS00,6E03STGF030VAS

Connection

