

E43003

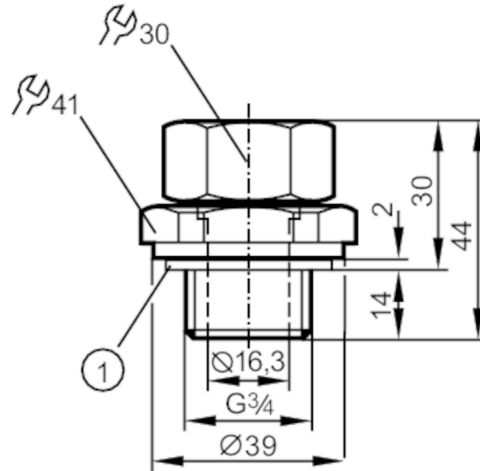

Mounting adapter for level sensors

MOUNTING ADAPTER G3/4



1 sealings

Application

Design	for capacitive level sensors LK, LI, LT, LL
Pressure rating [bar]	0.5

Operating conditions

Ambient temperature [°C]	0...80
--------------------------	--------

Mechanical data

Weight [g]	239.4
Materials	flange: stainless steel; Lock nut: stainless steel; spacer: brass; clamping ring: FKM; Sealing: Tesnit
Tightening torque [Nm]	6...9
Process connection	G 3/4

Remarks

Pack quantity	1 pcs.
---------------	--------