

E12064



Connection cable

STGH050MSS0008B03VDAA041--S

Status Archive

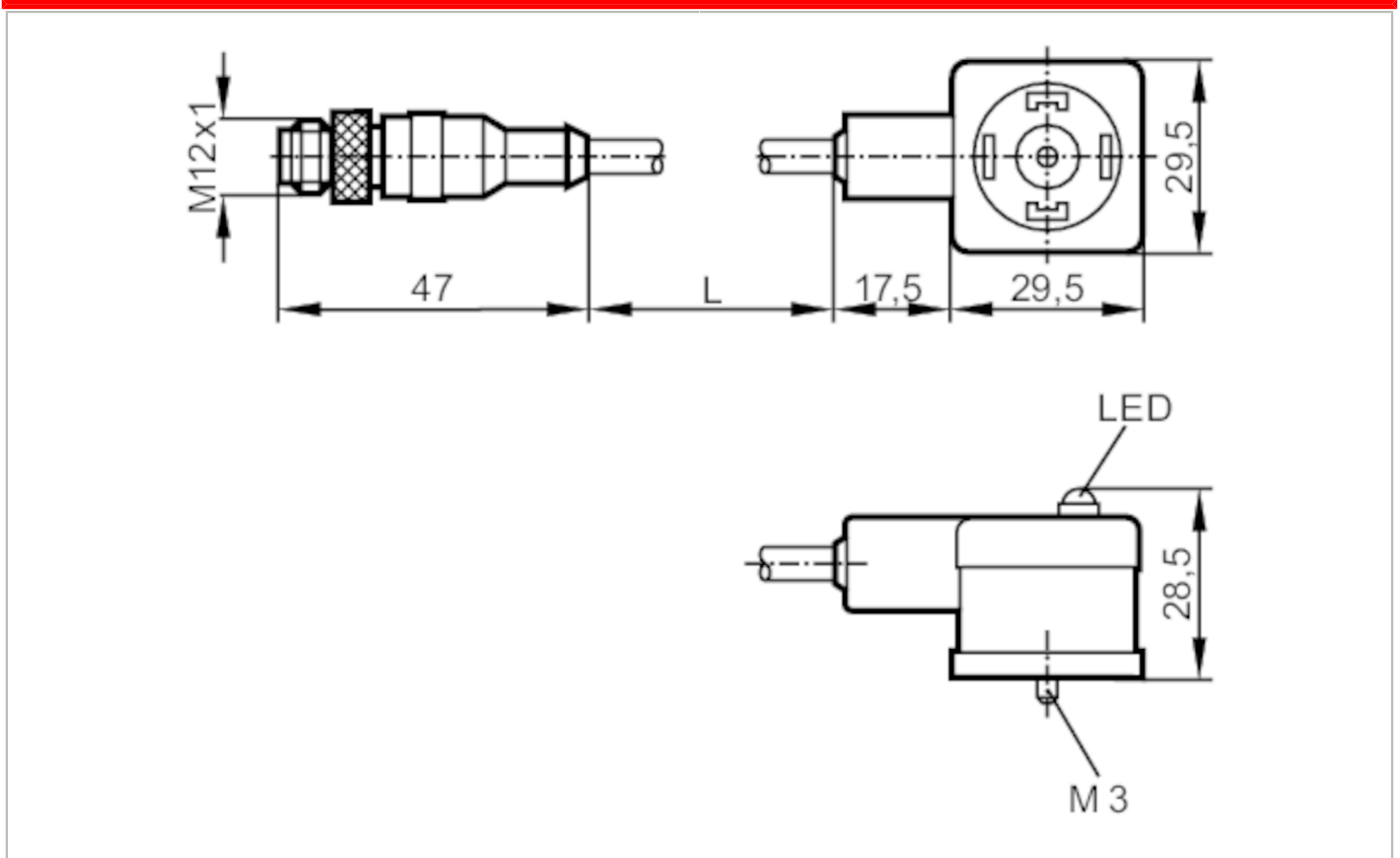

Application		
Free from silicone		yes
Electrical data		
Operating voltage	[V]	< 24 AC/DC
Overtoltage protection		free-wheeling diode
Operating conditions		
Ambient temperature	[°C]	-25...90
Protection		IP 67
Mechanical data		
Weight	[g]	400
Materials		TPU
Material nut		brass / brass
Displays / operating elements		
Display	operation	1 x LED, green
Accessories		
Accessories (supplied)		screw panel for labelling
Remarks		
Notes		discontinued article
Pack quantity		1 pcs.

E12064



Connection cable

STGH050MSS0008B03VDAA041--S

Electrical connection

Cable: 8 m, PUR / PVC, Halogen-free; 3 x 0.5 mm² (42 x Ø 0.1 mm)

Electrical connection - socket

Connector: 1 x valve type A DIN, angled; Moulded body: TPU; Locking: brass, nickel-plated; Contacts: nickel-plated brass

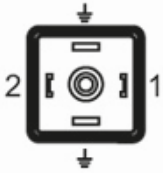

Electrical connection - plug

Connector: 1 x M12, straight; Moulded body: TPU; Locking: brass, nickel-plated; Contacts: gold-plated

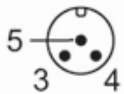

Connection

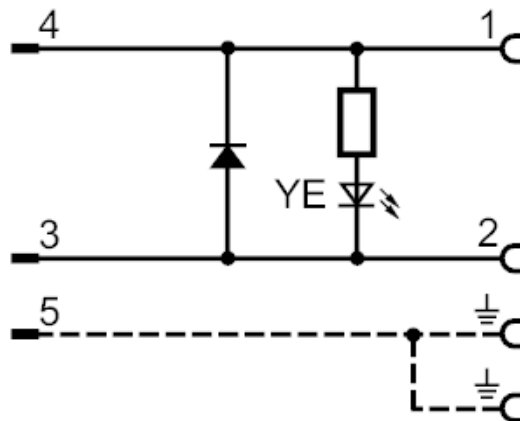

Status Archive