

# EVC301

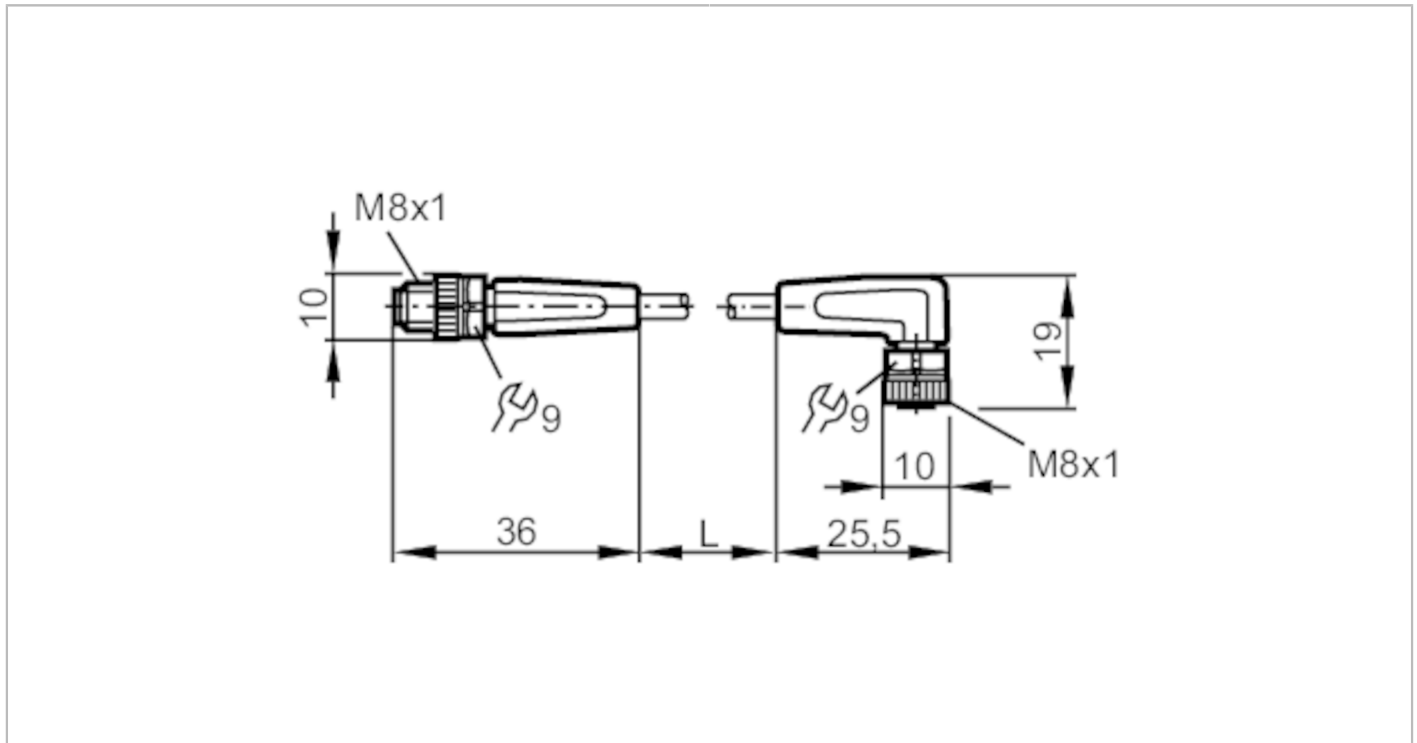

## Connection cable

VDOAF040MSS00,6H04STGF040MSS



Application		
Free from silicone	yes	
Electrical data		
Operating voltage [V]	< 50 AC / < 60 DC	
Protection class	III	
Max. current load total [A]	3	
Operating conditions		
Ambient temperature [°C]	-25...90	
Note on ambient temperature	cULus: ...80	
Ambient temperature (moving) [°C]	-25...90	
Note on ambient temperature (moving)	cULus: ...80	
Protection	IP 65; IP 67; IP 68; IP 69K	
Mechanical data		
Weight [g]	31.8	
Dimensions [mm]	10 x 10 x 36	
Materials	housing: TPU orange; Sealing: FKM	
Material nut	brass / brass	
Drag chain suitability	bending radius for flexible use	min. 10 x cable diameter
	travel speed	max. 3.3 m/s for a horizontal travel length of 5 m and max. acceleration of 5 m/s <sup>2</sup>
	bending cycles	> 5 Mio.
	torsional strain	± 180 °/m
Drag chain suitability	yes	

# EVC301



## Connection cable

VDOAF040MSS00,6H04STGF040MSS

### Remarks

Pack quantity

1 pcs.

### Electrical connection

Cable: 0.6 m, PUR, Halogen-free, black, Ø 3.7 mm; 4 x 0.25 mm<sup>2</sup> (32 x Ø 0.1 mm )

### Electrical connection - socket

Connector: 1 x M8, angled; Locking: brass, nickel-plated; Contacts: gold-plated; Tightening torque: 0.3...0.5 Nm



### Electrical connection - plug

Connector: 1 x M8, straight; Locking: brass, nickel-plated; Contacts: gold-plated; Tightening torque: 0.3...0.5 Nm



### Connection

