

EVT050

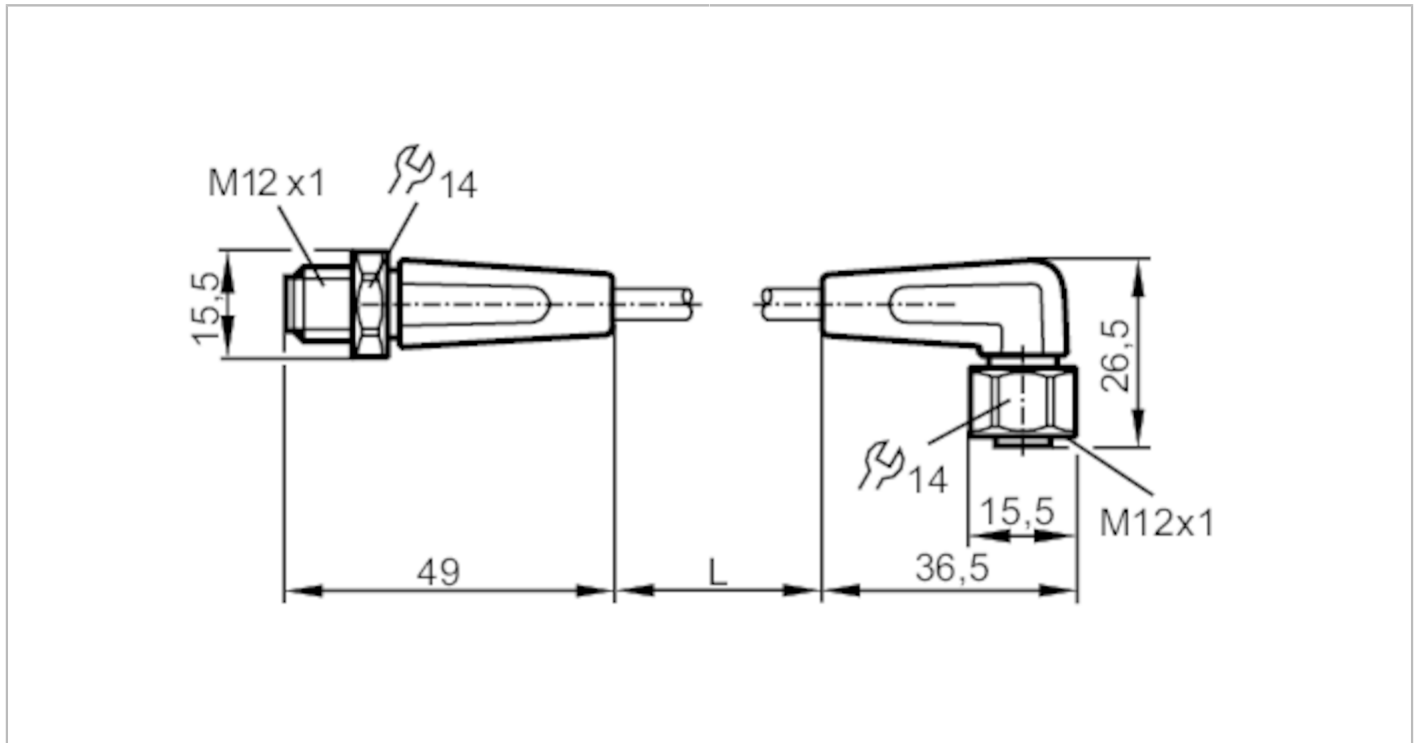

Connection cable

VDOAH040VAS0005E04STGH040VAS



Application		
Application	hygienic and wet areas in the food industry	
Free from silicone	yes	
Electrical data		
Operating voltage [V]	< 250 AC / < 300 DC	
Protection class	II	
Max. current load total [A]	4	
Operating conditions		
Ambient temperature [°C]	-25...100	
Note on ambient temperature	cULus: ...50	
Ambient temperature (moving) [°C]	5...100	
Note on ambient temperature (moving)	cULus: ...50	
Protection	IP 65; IP 67; IP 68; IP 69K	
Mechanical data		
Weight [g]	199.2	
Materials	housing: PVC orange; Sealing: EPDM	
Material nut	stainless steel (1.4404 / 316L) / stainless steel (1.4404 / 316L)	
Drag chain suitability	bending radius for flexible use	min. 10 x cable diameter
	travel speed	max. 3.3 m/s for a horizontal travel length of 5 m and max. acceleration of 5 m/s ²
	bending cycles	> 1 Mio.
	torsional strain	± 180 °/m
Drag chain suitability	yes	

EVT050



Connection cable

VDOAH040VAS0005E04STGH040VAS

Remarks

Pack quantity

1 pcs.

Electrical connection

Cable: 5 m, PVC, orange, Ø 4.9 mm; 4 x 0.34 mm² (42 x Ø 0.1 mm)

Electrical connection - socket

Connector: 1 x M12, angled; Locking: stainless steel (1.4404 / 316L); Contacts: gold-plated; Tightening torque: 0.6...1.5 Nm



Electrical connection - plug

Connector: 1 x M12, straight; Locking: stainless steel (1.4404 / 316L); Contacts: gold-plated; Tightening torque: 0.6...1.5 Nm



Connection

