

PT9542

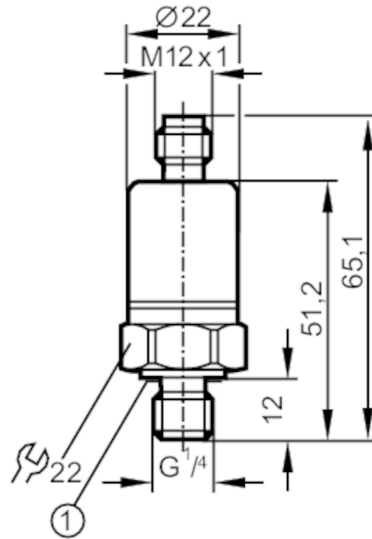

Pressure transmitter

PT-100-SBG14-B-DVG/US/ IW



1 Sealing
Tightening torque 25 Nm



Application

Application	for industrial applications
Media	liquids and gases
Medium temperature [°C]	-25...90
Pressure rating [bar]	200
Min. bursting pressure [bar]	1000
Type of pressure	relative pressure

Electrical data

Operating voltage [V]	16...36 DC
Current consumption [mA]	< 6
Min. insulation resistance [MΩ]	100; (500 V DC)
Protection class	III
Reverse polarity protection	yes

Outputs

Total number of outputs	1
Output signal	analogue signal
Number of analogue outputs	1
Analogue voltage output [V]	0...10
Min. load resistance [Ω]	2000

Measuring/setting range

Measuring range [bar]	0...100
-----------------------	---------

Accuracy / deviations

Repeatability [% of the span]	< ± 0,1; (with temperature fluctuations < 10 K)
Characteristics deviation	< ± 1,0; (incl. drift when overtightened, zero point and span error)

PT9542



Pressure transmitter

PT-100-SBG14-B-DVG/US/ W

	[% of the span]	
Linearity deviation	[% of the span]	$< \pm 0,25$ (BFSL) / $< \pm 0,5$ (LS)
Hysteresis deviation	[% of the span]	$< \pm 0,2$
Long-term stability	[% of the span]	$< \pm 0,1$; (per 6 months)
Temperature coefficient zero point	[% of the span / 10 K]	$< \pm 0,1$; (-25...90 °C)
Temperature coefficient span	[% of the span / 10 K]	$< \pm 0,1$; (-25...90 °C)

Response times

Step response time analogue output	[ms]	3
------------------------------------	------	---

Operating conditions

Ambient temperature	[°C]	-25...90
Storage temperature	[°C]	-40...100
Protection		IP 67; IP 69K

Tests / approvals

EMC	EN 61000-4-2 ESD	4 kV CD / 8 kV AD
	EN 61000-4-3 HF radiated	10 V/m
	EN 61000-4-4 Burst	4 kV coupling clamp
	EN 61000-4-5 Surge	1 kV signal for DC units
	EN 61000-4-6 HF conducted	10 V
Shock resistance	DIN IEC 68-2-27	50 g (11 ms)
Vibration resistance	DIN IEC 68-2-6	20 g (10...2000 Hz)
MTTF	[years]	1116

Mechanical data

Weight	[g]	80
Materials		stainless steel (1.4404 / 316L); PA
Materials (wetted parts)		stainless steel (1.4404 / 316L); FKM
Min. pressure cycles		50 million
Process connection		threaded connection G 1/4 external thread

Remarks

Remarks	BFSL = Best Fit Straight Line LS = limit value setting
Notes	discontinued article
Pack quantity	1 pcs.

Electrical connection

Connector: 1 x M12

PT9542

Pressure transmitter

PT-100-SBG14-B-DVG/US/ IW



Connection

