

E21202

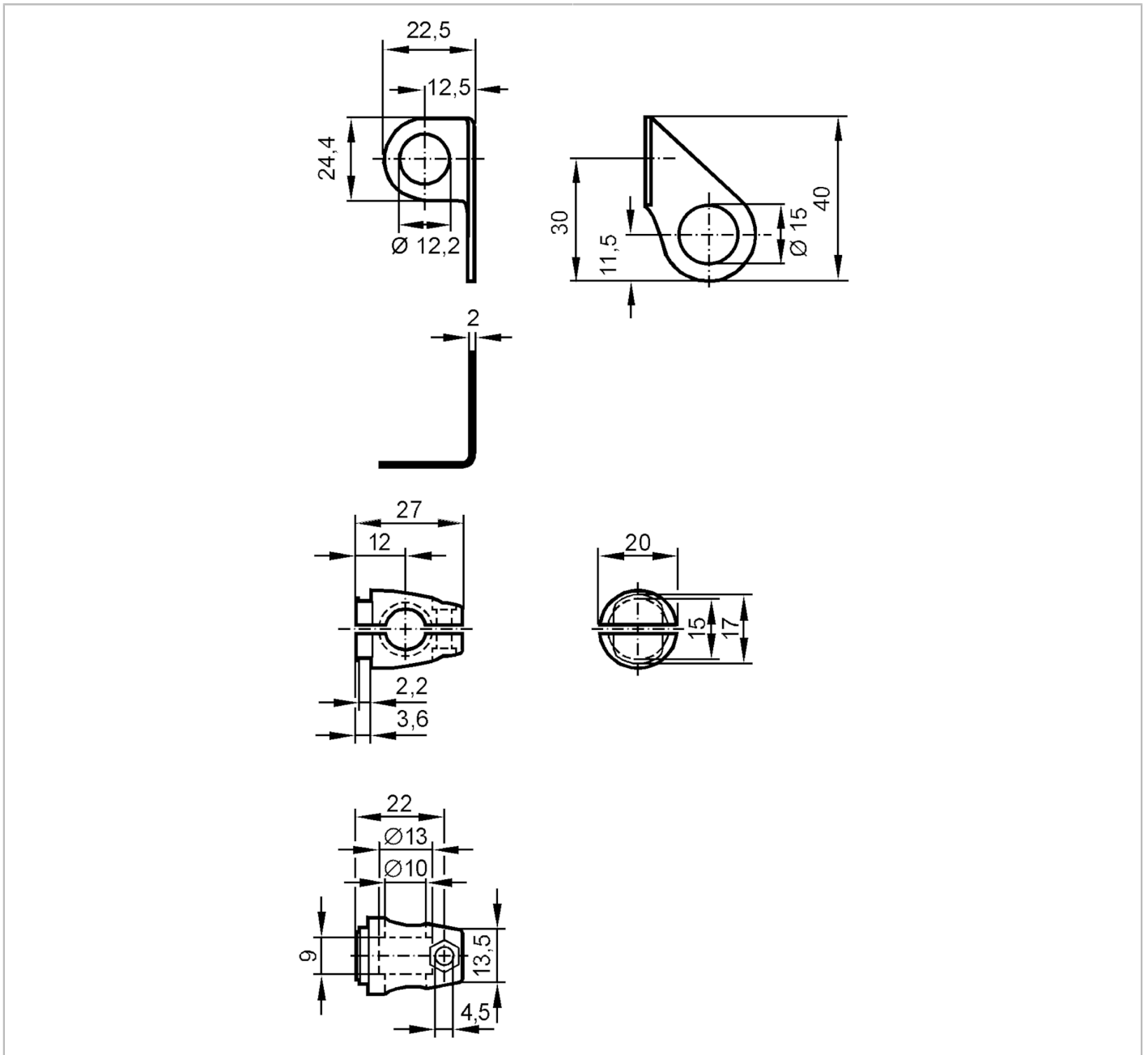

Mounting set for position sensors

M12 ANGLE BRACKET 200



Application	
Design	clamp mounting
Mechanical data	
Weight [g]	47.2
Type of mounting	Mounting rod; ($\varnothing 10$ mm)
Dimensions [mm]	$\varnothing 12.2$
Materials	fixture: stainless steel (1.4571/316Ti); Clamp: diecast zinc
Remarks	
Pack quantity	1 pcs.