

IB0029

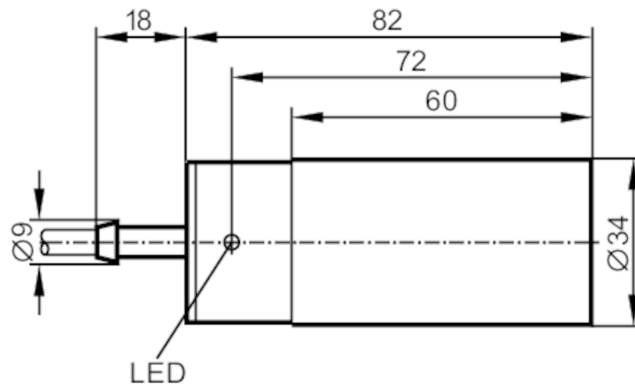

Inductive sensor

IB-2030-ABOA/6M



Electrical data

Operating voltage	[V]	20...250 AC/DC
Protection class		II
Reverse polarity protection		no

Outputs

Output function		normally open
Max. voltage drop switching output DC	[V]	6
Max. voltage drop switching output AC	[V]	6.5
Minimum load current	[mA]	5
Max. leakage current	[mA]	2.5 (250 V AC) / 1.3 (110 V AC) / 0.8 (24 V DC)
Permanent current rating of switching output AC	[mA]	250; (350 (...50 °C))
Permanent current rating of switching output DC	[mA]	100
Short-time current rating of switching output	[mA]	2200; (20 ms / 0,5 Hz)
Switching frequency AC	[Hz]	25
Switching frequency DC	[Hz]	50
Short-circuit proof		no
Overload protection		no

Detection zone

Sensing range	[mm]	30
Real sensing range Sr	[mm]	30 ± 10 %
Operating distance	[mm]	0...24.3

Accuracy / deviations

Correction factor		steel: 1 / stainless steel: 0.7 / brass: 0.4 / aluminium: 0.3 / copper: 0.2
Hysteresis	[% of Sr]	1...15
Switch point drift	[% of Sr]	-10...10

IB0029



Inductive sensor

IB-2030-ABOA/6M

Operating conditions		
Ambient temperature	[°C]	-25...80
Protection		IP 67
Tests / approvals		
EMC	EN 60947-5-2	
	EN 55011	class B
MTTF	[years]	607
Mechanical data		
Weight	[g]	423.4
Housing		cylindrical
Mounting		non-flush mountable
Dimensions	[mm]	Ø 34 / L = 82
Materials		PBT
Displays / operating elements		
Display	switching status	1 x LED, yellow
Electrical connection		
Required protection	miniature fuse to IEC60127-2 sheet 1; ≤ 2 A; fast acting	
Accessories		
Accessories (supplied)	Mounting clamps: 1	
Remarks		
Remarks	Recommendation: Check the safe functioning of the unit after a short circuit.	
Pack quantity	1 pcs.	
Electrical connection		
Cable: 6 m, PVC; 2 x 0.5 mm ²		

Connection

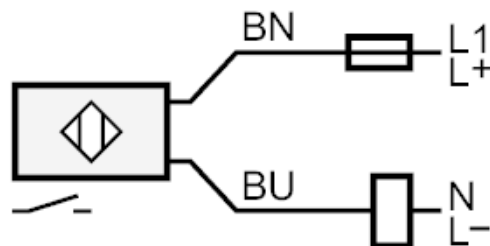

Note miniature fuse to IEC60127-2 sheet 1 ≤ 2 A fast acting

Core colours :

BN = brown
BU = blue