

E12209

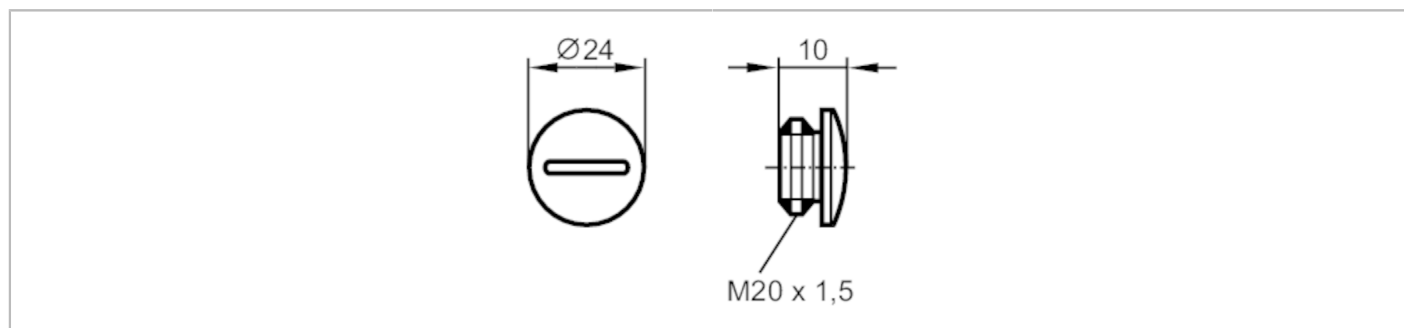

Protective cap

PROTECTION CAP M20X1,5



Operating conditions		
Ambient temperature	[°C]	-20...100
Mechanical data		
Weight	[g]	5.6
Dimensions	[mm]	M20 x 1.5
Thread designation		M20 x 1.5
Materials		PA 6.6
Tightening torque	[Nm]	3.5
Remarks		
Pack quantity		2 pcs.