

E37640

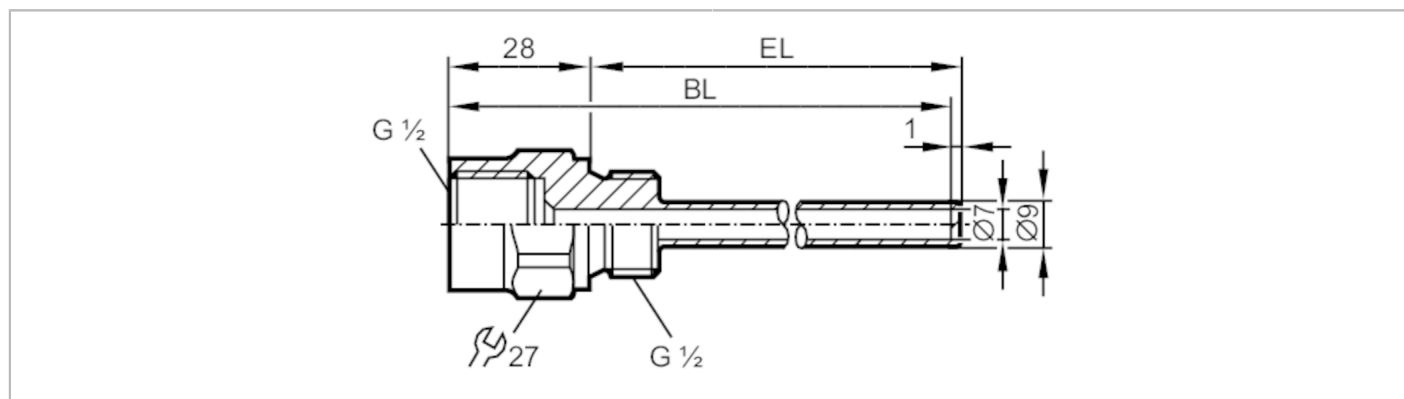

Thermowell for temperature sensors

THERMOWELL, D6/ G1/2 /L=250



Application	
Design	for temperature sensors EL = 250 mm
Pressure rating [bar]	100
Note on pressure rating	< 250 °C
Mechanical data	
Weight [g]	170.8
Materials	stainless steel (1.4571/316Ti)
Sensor connection	G 1/2 Ø 6 mm
Process connection	G 1/2
Installation length EL [mm]	224
Bore length BL [mm]	250
Remarks	
Pack quantity	1 pcs.