

PT2415

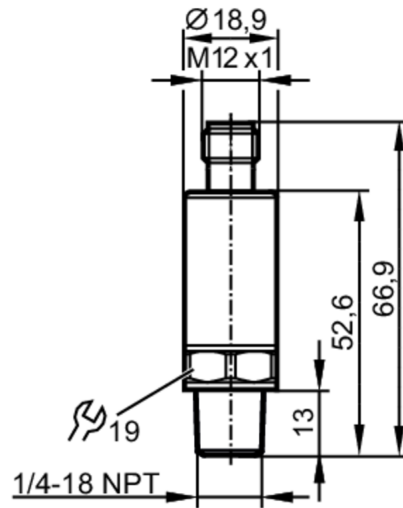

Pressure transmitter

PT-010PSEN14-A-ZVG/US/ IW



Application	
Application	for industrial applications
Media	liquids and gases
Medium temperature [°C]	-40...90
Pressure rating [psi]	250
Note on pressure rating	static
Min. bursting pressure [psi]	2900
Vacuum resistance [psi]	-14.5
Type of pressure	relative pressure
MAWP (for applications according to CRN) [psi]	250
Electrical data	
Operating voltage [V]	8.5...36 DC
Min. insulation resistance [MΩ]	100; (500 V DC)
Protection class	III
Reverse polarity protection	yes
Outputs	
Total number of outputs	1
Output signal	analogue signal
Number of analogue outputs	1
Analogue current output [mA]	4...20
Max. load [Ω]	720; (U _b = 24 V; (U _b - 8,5 V) / 21,5 mA)
Short-circuit proof	yes
Overload protection	yes
Measuring/setting range	
Measuring range [psi]	0...100

PT2415



Pressure transmitter

PT-010PSEN14-A-ZVG/US/ IW

Accuracy / deviations	
Repeatability [% of the span]	< ± 0,05; (with temperature fluctuations < 10 K)
Characteristics deviation [% of the span]	< ± 0,5; (incl. drift when overtightened, zero point and span error, non-linearity, hysteresis)
Linearity deviation [% of the span]	< ± 0,1 (BFSL) / < ± 0,2 (LS)
Hysteresis deviation [% of the span]	< ± 0,2
Long-term stability [% of the span]	< ± 0,1; (per 6 months)
Temperature coefficient zero point and span [% of the span / 10 K]	< 0,1 (-25...90 °C) / < 0,2 (-40...-25 °C)
Response times	
Step response time analogue output [ms]	1
Operating conditions	
Ambient temperature [°C]	-40...90
Storage temperature [°C]	-40...100
Protection	IP 67; IP 69K
Tests / approvals	
EMC	DIN EN 61000-6-2 DIN EN 61000-6-3
Shock resistance	DIN EN 60068-2-27 50 g (11 ms)
Vibration resistance	DIN EN 60068-2-6 20 g (10...2000 Hz)
MTTF [years]	784
Pressure Equipment Directive	Sound Engineering Practice; can be used for group 2 fluids; group 1 fluids on request
Mechanical data	
Weight [g]	57.5
Materials	1.4542 (17-4 PH / 630); stainless steel (1.4404 / 316L); PEI
Materials (wetted parts)	1.4542 (17-4 PH / 630)
Min. pressure cycles	60 million; (at 1.2 times nominal pressure)
Tightening torque [Nm]	< 50; (recommended tightening torque; depends on lubrication, seal and pressure rating)
Process connection	threaded connection 1/4 NPT external thread
Restrictor element integrated	no (can be retrofitted)
Remarks	
Remarks	BFSL = Best Fit Straight Line LS = limit value setting
Pack quantity	1 pcs.
Electrical connection	
Connector: 1 x M12	

PT2415

Pressure transmitter

PT-010PSEN14-A-ZVG/US/ IW



Connection

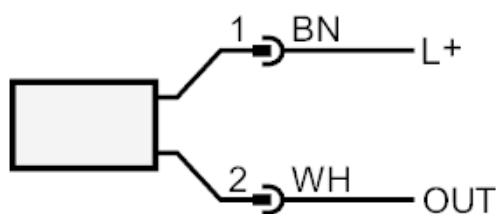

OUT analogue output
 colours to DIN EN 60947-5-2
 Core colours :

BN = brown
WH = white