

E43001

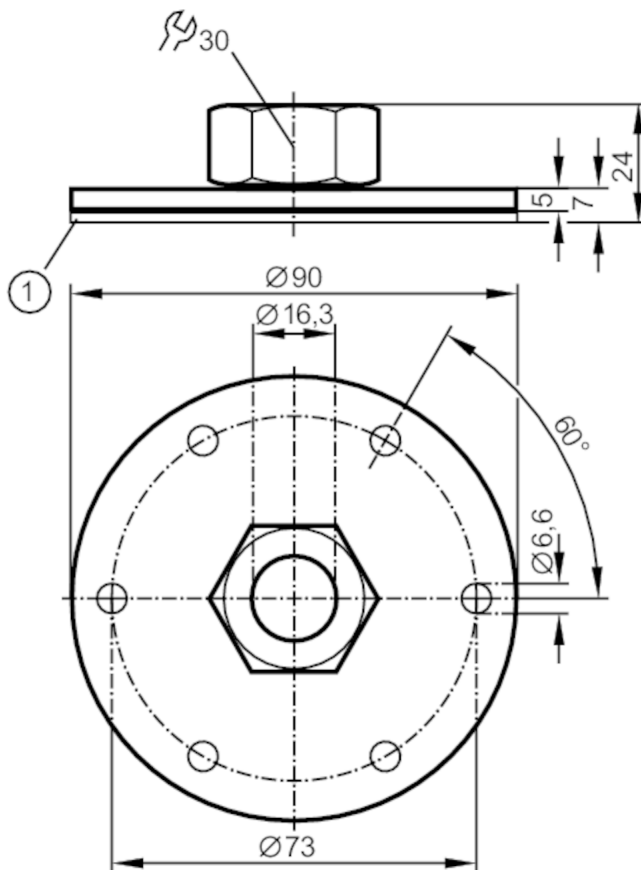

Flange plate for level sensors

FLANGE PLATE 73-90 D16



1 sealings

Application	
Design	for capacitive level sensors LK, LI, LT, LL
Installation	according to DIN 24557
Pressure rating [bar]	0.5
Operating conditions	
Ambient temperature [°C]	0...80
Mechanical data	
Weight [g]	185
Type of mounting	according to DIN 24557
Materials	aluminium anodised; Lock nut: stainless steel; spacer: brass; clamping ring: FKM; Sealing: NBR
Tightening torque [Nm]	6...9
Remarks	
Pack quantity	1 pcs.