



Main

Product or component type	Servo motor
Device short name	BSH
Maximum mechanical speed	10000 rpm
Continuous stall torque	0.38 N.m for LXM32.U60N4 at 1.5 A, 480 V, three phase 0.38 N.m for LXM32.U60N4 at 1.5 A, 400 V, three phase 0.38 N.m for LXM32.U45M2 at 1.5 A, 230 V, single phase
Peak stall torque	1.37 N.m for LXM32.U60N4 at 1.5 A, 480 V, three phase 1.37 N.m for LXM32.U60N4 at 1.5 A, 400 V, three phase 1.37 N.m for LXM32.U45M2 at 1.5 A, 230 V, single phase
Nominal output power	275 W for LXM32.U60N4 at 1.5 A, 480 V, three phase 289 W for LXM32.U60N4 at 1.5 A, 400 V, three phase 152 W for LXM32.U45M2 at 1.5 A, 230 V, single phase
Nominal torque	0.292 N.m for LXM32.U60N4 at 1.5 A, 480 V, three phase 0.307 N.m for LXM32.U60N4 at 1.5 A, 400 V, three phase 0.364 N.m for LXM32.U45M2 at 1.5 A, 230 V, single phase
Nominal speed	9000 rpm for LXM32.U60N4 at 1.5 A, 480 V, three phase 9000 rpm for LXM32.U60N4 at 1.5 A, 400 V, three phase 4000 rpm for LXM32.U45M2 at 1.5 A, 230 V, single phase
Shaft end	Keyed
IP degree of protection	IP65 standard
Speed feedback resolution	32768 points/turn x 4096 turns
Holding brake	Without
Mounting support	International standard flange
Electrical connection	Rotatable right-angled connectors

Complementary

Range compatibility	Lexium 32
Supply voltage max	400 V
Network number of phases	Three phase
Continuous stall current	1.5 A

Maximum continuous power	398 W
Maximum current Irms	6 A for LXM32.U60N4 at 480 V 6 A for LXM32.U60N4 at 400 V 6 A for LXM32.U45M2 at 230 V
Maximum permanent current	1.5 A
Switching frequency	8 kHz
Second shaft	Without second shaft end
Shaft diameter	8 mm
Shaft length	25 mm
Key width	12 mm
Feedback type	Multiturn SinCos Hiperface
Motor flange size	40 mm
Number of motor stacks	2
Torque constant	0.253 N.m/A at 120 °C
Back emf constant	18 V/krpm at 20 °C
Number of motor poles	10
Rotor inertia	0.0419 kg.cm ²
Stator resistance	11.6 Ohm at 20 °C
Stator inductance	12.8 mH at 20 °C
Stator electrical time constant	1.1 ms at 20 °C
Maximum axial force Fa	0.2 x Fr
Type of cooling	Natural convection
Length	93.4 mm
Centring collar diameter	30 mm
Centring collar depth	2.5 mm
Number of mounting holes	4
Mounting holes diameter	4.5 mm
Circle diameter of the mounting holes	46 mm
Product weight	0.6 kg

Offer Sustainability

Sustainable offer status	Green Premium product
REACH Regulation	REACH Declaration
EU RoHS Directive	Pro-active compliance (Product out of EU RoHS legal scope) EU RoHS Declaration
Mercury free	Yes
RoHS exemption information	Yes
China RoHS Regulation	China RoHS declaration
Environmental Disclosure	Product Environmental Profile
Circularity Profile	No need of specific recycling operations
WEEE	The product must be disposed on European Union markets following specific waste collection and never end up in rubbish bins

Contractual warranty

Warranty	18 months
----------	-----------

Servo Motors Dimensions

For Servo Motor without Brake

Front view

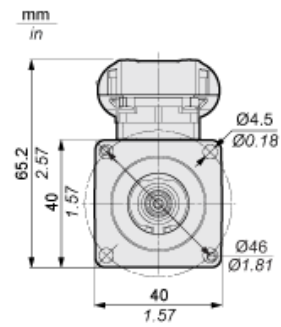

Left view

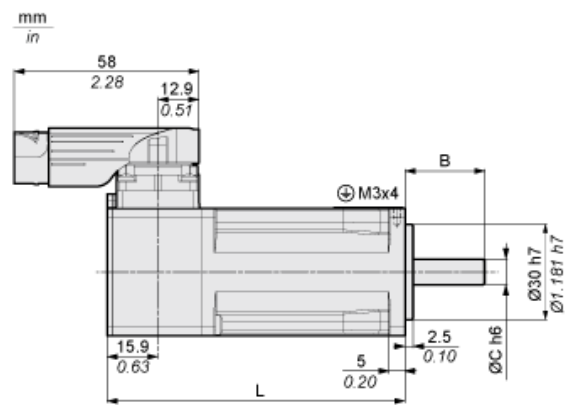

DIN 6885 A

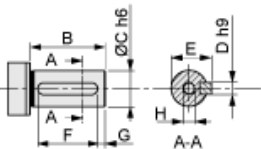

	Dimensions in mm	Dimensions in in.
L	93.4	3.68
B	25	0.98
C	8	0.31
D	3	0.12
E	9.2	0.36
F	12	0.47
G	4	0.16
H	DIN 332 DS M3 x 9	
A	DIN 6885-A3x3x12	