



Main

Range compatibility	Lexium 23 Plus
Product or component type	Servo motor
Device short name	BCH

Complementary

Maximum mechanical speed	3000 rpm
[Us] rated supply voltage	220 V
Network number of phases	Three phase
Continuous stall current	11.01 A
Continuous power	2 kW
Shaft end	Smooth shaft
Second shaft	Without second shaft end
Shaft diameter	22 mm
Shaft length	47 mm
Feedback type	20 bits incremental encoder
Holding brake	Without
Mounting support	Asian standard flange
Motor flange size	130 mm
Torque constant	0.87 N.m/A
Back emf constant	31.8 V/krpm at 20 °C
Rotor inertia	14.59 kg.cm ²
Stator resistance	0.348 Ohm at 20 °C
Stator inductance	5.52 mH at 20 °C
Stator electrical time constant	15.86 ms at 20 °C
Maximum radial force Fr	490 N
Maximum axial force Fa	98 N
Brake pull-in power	19 W
Type of cooling	Natural convection
Length	187.5 mm
Number of motor stacks	4
Centring collar diameter	110 mm

Disclaimer: This documentation is not intended as a substitute for and is not to be used for determining suitability or reliability of these products for specific user applications

Centring collar depth	6 mm
Number of mounting holes	4
Mounting holes diameter	9 mm
Circle diameter of the mounting holes	145 mm
Distance shaft shoulder-flange	47 mm
Product weight	7.8 kg

Environment

IP degree of protection	IP65
Ambient air temperature for operation	0...40 °C

Contractual warranty

Warranty	18 months
----------	-----------

Dimensions

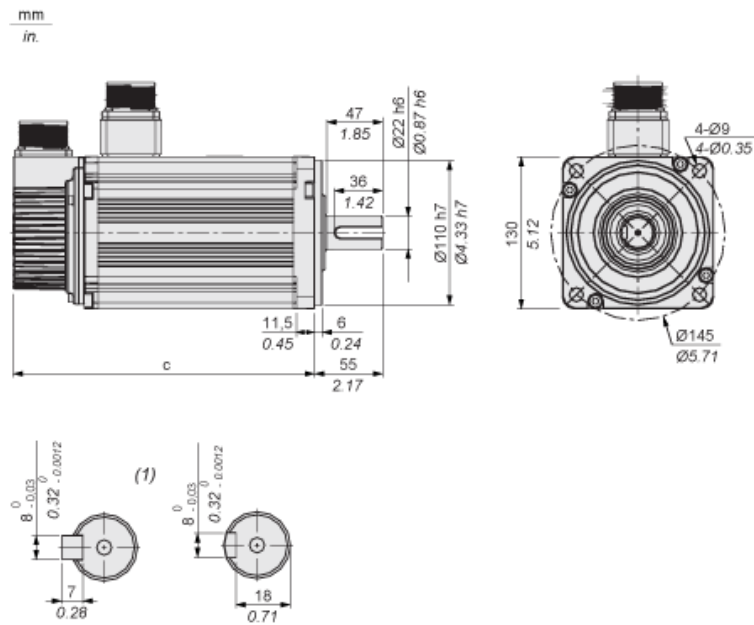

(1) Shaft end, keyed slot (optional)

Dimensions in mm

c (without holding brake)	c (with holding brake)
187.5	216

Dimensions in in.

c (without holding brake)	c (with holding brake)
7.38	8.50

Torque/Speed Curves with 220 V Three Phase Supply Voltage

Servo Motor with LXM23•U20M3X Servo Drive

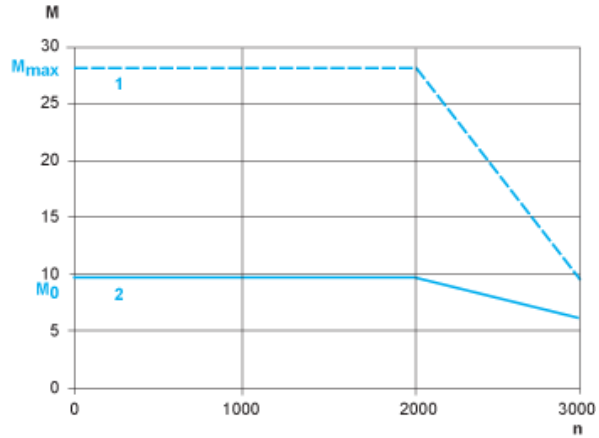

- M : Torque in Nm
- n : Speed in rpm
- 1 : Peak torque
- 2 : Continuous torque