

Schreib-/Lesekopf IQH1-18GM-V1

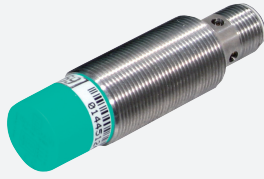

- Arbeitsfrequenz 13,56 MHz
- Konform mit ISO 15693
- Für FRAM-Transponder geeignet
- Schreib-/Lesekopf mit Gewinde M18 x 1
- Anschluss über Steckverbinder V1 (M12 x 1)
- Mehrloch-LED zur Funktionsanzeige
- Schutzart IP67
- Zum Anschluss an IDENTControl-Auswerteeinheit

Schreib-/Lesekopf HF, ISO 15693 für IDENTControl



Abmessungen

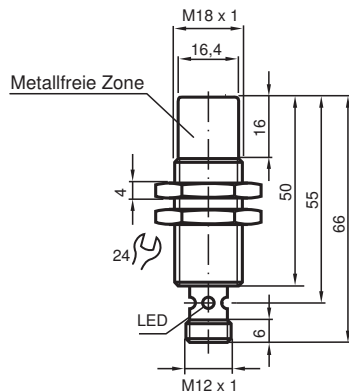

Technische Daten

Allgemeine Daten

Arbeitsfrequenz	13,56 MHz
Übertragungsrate	26 kBit/s
Erfassungsbereich	
Leseabstand	0 ... 50 mm
Schreibabstand	0 ... 50 mm
Breite	max. 45 mm
UL File Number	E87056 nur in Verbindung mit einer SELV- oder PELV-Energiequelle oder einer nach UL for Class 2 gelisteten Energiequelle

Kenndaten funktionale Sicherheit

MTTF _d	750 a
Gebrauchsdauer (T _M)	10 a
Diagnosedeckungsgrad (DC)	0 %

Anzeigen/Bedienelemente

LED grün/gelb	Mehrloch-LED: grün: Power on grün blinkend: Schreib-/Leseversuch wird ausgeführt gelb: Datenträger erkannt
---------------	---

Veröffentlichungsdatum: 2020-03-23 Ausgabedatum: 2020-03-27 Dateiname: 204622_ger.pdf

Beachten Sie „Allgemeine Hinweise zu Pepperl+Fuchs-Produktinformationen“.

Pepperl+Fuchs-Gruppe
www.pepperl-fuchs.com

USA: +1 330 486 0001
fa-info@us.pepperl-fuchs.com

Deutschland: +49 621 776 1111
fa-info@de.pepperl-fuchs.com

Singapur: +65 6779 9091
fa-info@sg.pepperl-fuchs.com

PEPPERL+FUCHS

Technische Daten

Elektrische Daten

Leistungsaufnahme	P_0	$\leq 1,2 \text{ W}$
Versorgung		aus der IDENTControl

Richtlinienkonformität

Funkanlagen		
Richtlinie 2014/53/EU		EN 301489-1 EN 301489-3 EN 300330 EN 62368-1 EN 50364
RoHS		
Richtlinie 2011/65/EU (RoHS)		EN 50581

Normenkonformität

Schutzart		EN 60529
RFID		ISO/IEC 15693-2 ISO/IEC 15693-3 ISO/IEC 18000-3

Zulassungen und Zertifikate

FCC-Zulassung		This device complies with part 15 of the FCC rules. Operation is subject to the following two conditions: (1) This device may not cause harmful interference, and (2) This device must accept any interference received, including interference that may cause undesired operation. Caution: Changes or modifications not expressly approved by the party responsible for compliance could void the user's authority to operate the equipment.
KCC-Zulassung		KCC-CRI-PF1-IQH1-18GM-V1

Umgebungsbedingungen

Umgebungstemperatur		-25 ... 70 °C (-13 ... 158 °F)
Lagertemperatur		-40 ... 85 °C (-40 ... 185 °F)



Mechanische Daten

Schutzart		IP67
Anschluss		Steckverbinder M12 x 1
Material		
Gehäuse		PBT/Edelstahl
Vergussmasse/Härter		CY 221/HY 2966
Montage		nicht bündig
Abstand zwischen zwei Köpfen		Multiplex on: $\geq 30 \text{ mm}$ Multiplex off: $\geq 80 \text{ mm}$
Masse		ca. 40 g

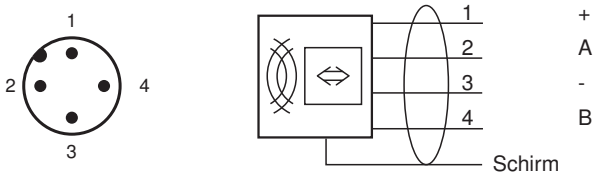



















Anschluss



Zubehör

	IC-KP-B6-V15B	187,5 kBit/s
	IC-KP-B6-V15B	Auswerteeinheit IDENTControl mit PROFIBUS-DP-Schnittstelle

Zubehör



	IC-KP-B17-AIDA1	Auswerteeinheit IDENTControl mit Ethernet-Schnittstelle für Protokolle TCP/IP, PROFINET, EtherNet/IP, MODBUS TCP
	IC-KP2-2HRX-2V1	Auswerteeinheit IDENTControl Compact mit serieller Schnittstelle RS-232 und RS-485
	IC-KP2-2HRX-2V1	DP 1
	IC-KP2-2HB6-V15B	Kommunikationsprotokoll
	IC-KP2-2HB6-V15B	Auswerteeinheit IDENTControl Compact mit PROFIBUS-DP-Schnittstelle
	IC-KP2-2HB17-2V1D	Auswerteeinheit IDENTControl Compact mit Ethernet-Schnittstelle für Protokolle TCP/IP, PROFINET, EtherNet/IP, MODBUS TCP
	IC-KP2-2HB17-2V1D	1 MBit/s
	IC-KP2-2HB21-2V1D	Auswerteeinheit IDENTControl Compact mit EtherCAT-Schnittstelle
	IQC21-8 10pcs	Datenträger
	IQC21-10 10pcs	Datenträger
	IQC21-12.4 10pcs	Datenträger
	IQC21-16 50pcs	Datenträger
	IQC21-30 25pcs	Datenträger
	IQC21-50F-T10	Datenträger
	IQC21-58	Datenträger
	IQC22-22-T9 50pcs	Datenträger
	IQC33-20 50pcs	Datenträger
	IQC33-30 25pcs	Datenträger
	IQC33-50 25pcs	Datenträger
	V1-G-2M-PUR-ABG-V1-W	Verbindungskabel, M12 auf M12, PUR-Kabel 4-polig, geschirmt

Veröffentlichungsdatum: 2020-03-23 Ausgabedatum: 2020-03-27 Dateiname: 204622_ger.pdf

Beachten Sie „Allgemeine Hinweise zu Pepperl+Fuchs-Produktinformationen“.

Pepperl+Fuchs-Gruppe
www.pepperl-fuchs.comUSA: +1 330 486 0001
fa-info@us.pepperl-fuchs.comDeutschland: +49 621 776 1111
fa-info@de.pepperl-fuchs.comSingapur: +65 6779 9091
fa-info@sg.pepperl-fuchs.com PEPPERL+FUCHS

Zubehör

	V1-G-5M-PUR-ABG-V1-W	Verbindungskabel, M12 auf M12, PUR-Kabel 4-polig, geschirmt
	V1-G-10M-PUR-ABG-V1-W	Verbindungskabel, M12 auf M12, PUR-Kabel 4-polig, geschirmt

Sicherheitsinformation

This equipment has been tested and found to comply with the limits for a Class A digital device, pursuant to part 15 of the FCC Rules. These limits are designed to provide reasonable protection against harmful interference when the equipment is operated in a commercial environment. This equipment generates, uses, and can radiate radio frequency energy and, if not installed and used in accordance with the instruction manual, may cause harmful interference to radio communications. Operation of this equipment in a residential area is likely to cause harmful interference in which case the user will be required to correct the interference at his own expense.

Veröffentlichungsdatum: 2020-03-23 Ausgabedatum: 2020-03-27 Dateiname: 204622_ger.pdf

Beachten Sie „Allgemeine Hinweise zu Pepperl+Fuchs-Produktinformationen“.

Pepperl+Fuchs-Gruppe
www.pepperl-fuchs.com

USA: +1 330 486 0001
fa-info@us.pepperl-fuchs.com

Deutschland: +49 621 776 1111
fa-info@de.pepperl-fuchs.com

Singapur: +65 6779 9091
fa-info@sg.pepperl-fuchs.com

 **PEPPERL+FUCHS**