

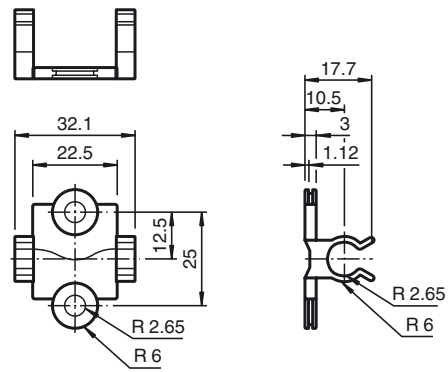

Dimensions



Model Number

MH V3-Holder

Modular universal holder for M8 connectors

Features

- Modular universal holder
- Free from substances that impair paint wetting

Technical data

Ambient conditions

Installation temperature -25 ... 85 °C (-13 ... 185 °F)

Mechanical specifications

Connection 9 mm

Installation Distance between mounting holes: 25 mm

Note Packaging unit, 10-piece

Installation Note

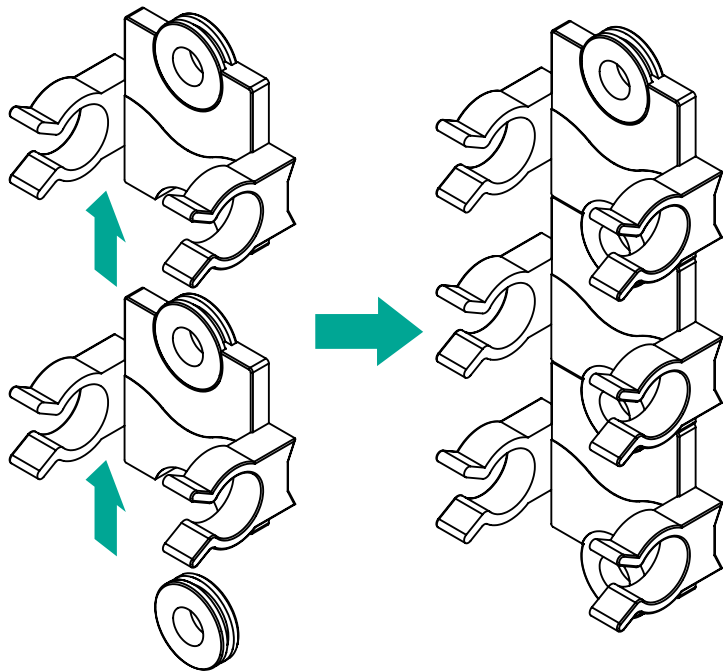

Release date: 2019-06-12 08:07 Date of issue: 2019-06-12 318647_eng.xml