

Read/write head

IPH-18GM-V1

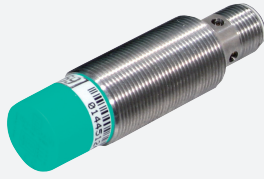

- Read/write head with thread M18 x 1
- Connection via V1 (M12 x 1) plug connection
- Multihole-LED for function display
- Degree of protection IP67
- For connection to IDENTControl control interface

LF read/write head for IDENTControl



Dimensions

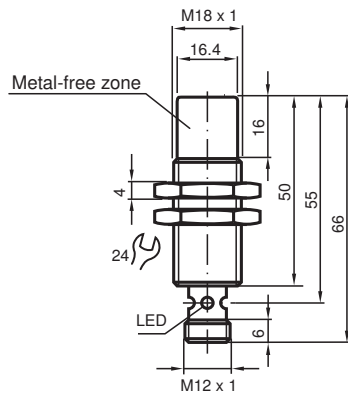

Technical Data

General specifications	
Operating frequency	125 kHz
Transfer rate	2 kBit/s
Sensing range	
Read distance	1 ... 50 mm
Write distance	0 ... 40 mm
Width	max. 40 mm
Operating distance	maximum: 50 mm
UL File Number	E87056
Functional safety related parameters	
MTTF _d	700 a
Mission Time (T _M)	10 a
Diagnostic Coverage (DC)	0 %
Indicators/operating means	

Release date: 2020-03-21 Date of issue: 2020-03-27 Filename: 121115_eng.pdf

Refer to "General Notes Relating to Pepperl+Fuchs Product Information".

Pepperl+Fuchs Group
www.pepperl-fuchs.com

USA: +1 330 486 0001
fa-info@us.pepperl-fuchs.com

Germany: +49 621 776 1111
fa-info@de.pepperl-fuchs.com

Singapore: +65 6779 9091
fa-info@sg.pepperl-fuchs.com

PEPPERL+FUCHS

Technical Data

LED green/yellow		Multihole-LED: green: power on green flashing: read/write attempt performed yellow: data carrier detected
Electrical specifications		
Power consumption	P ₀	≤ 1.2 W
Supply		from the IDENTControl
Directive conformity		
Radio equipment		
Directive 2014/53/EU		EN 301489-1 EN 301489-3 EN 300330 EN 62368-1 EN 50364
RoHS		
Directive 2011/65/EU (RoHS)		EN 50581
Standard conformity		
Degree of protection		EN 60529
RFID		ISO/IEC 18000-2
Ambient conditions		
Ambient temperature		-25 ... 70 °C (-13 ... 158 °F)
Storage temperature		-40 ... 85 °C (-40 ... 185 °F)
Mechanical specifications		
Degree of protection		IP67
Connection		connector M12 x 1
Material		
Housing		PBT/stainless steel
Encapsulation compound		Fermadur
Installation		
Distance between two heads		Multiplex on: ≥ 30 mm Multiplex off: ≥ 180 mm
Mass		approx. 40 g

Connection

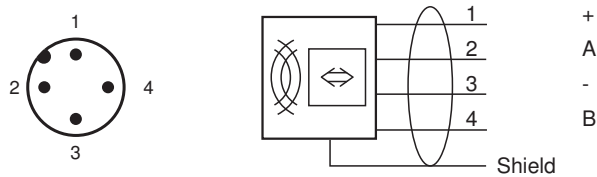

















Accessories

	IC-KP-B6-V15B	187.5 kBit/s
	IC-KP-B6-V15B	Control interface unit IDENTControlwith PROFIBUS DP interface
	IC-KP-B17-AIDA1	IDENTControl control interfaceWith Ethernet interface for TCP/IP, PROFINET, EtherNet/IP, and MODBUS TCP protocols
	IC-KP2-2HRX-2V1	Control interface unit IDENTControl Compactwith serial interface RS-232 and RS-485

Release date: 2020-03-21 Date of issue: 2020-03-27 Filename: 121115_eng.pdf

Refer to "General Notes Relating to Pepperl+Fuchs Product Information".

Accessories

	IC-KP2-2HRX-2V1	DP 1
	IC-KP2-2HB6-V15B	Protocol
	IC-KP2-2HB6-V15B	Control interface unit IDENTControl Compactwith PROFIBUS DP interface
	IC-KP2-2HB17-2V1D	IDENTControl Compact control interfaceWith Ethernet interface for TCP/IP, PROFINET, EtherNet/IP, and MODBUS TCP protocols
	IC-KP2-2HB17-2V1D	1 MBit/s
	IC-KP2-2HB21-2V1D	Control interface unit IDENTControl Compactwith EtherCAT interface
	IPC02-12 50pcs	Code carrier
	IPC02-26-T6 10pcs	Code carrier
	IPC02-50P	Code carrier
	IPC03-C1 10pcs	Data carrier
	IPC03-12.4 10pcs	Data carrier
	IPC03-30P	Data carrier
	IPC03-50P	Data carrier
	IPC03-58	Data carrier
	V1-G-2M-PUR-ABG-V1-W	Connecting cable, M12 to M12, PUR cable 4-pin, shielded
	V1-G-5M-PUR-ABG-V1-W	Connecting cable, M12 to M12, PUR cable 4-pin, shielded
	V1-G-10M-PUR-ABG-V1-W	Connecting cable, M12 to M12, PUR cable 4-pin, shielded

Release date: 2020-03-21 Date of issue: 2020-03-27 Filename: 121115_eng.pdf

Refer to "General Notes Relating to Pepperl+Fuchs Product Information".

Pepperl+Fuchs Group
www.pepperl-fuchs.comUSA: +1 330 486 0001
fa-info@us.pepperl-fuchs.comGermany: +49 621 776 1111
fa-info@de.pepperl-fuchs.comSingapore: +65 6779 9091
fa-info@sg.pepperl-fuchs.com **PEPPERL+FUCHS**