



Model Number

NBB20-U2-UU

Features

- Sensor head bidirectional and rotatable
- NO/NC selectable
- Comfort series
- 20 mm flush

Accessories

MHW 01

Modular mounting bracket

Technical Data

General specifications

Switching function		Normally open/closed (NO/NC)
Output type		Two-wire
Rated operating distance	s_n	20 mm
Installation		flush
Output polarity		AC/DC
Assured operating distance	s_a	0 ... 16.2 mm
Actual operating distance	s_r	18 ... 22 mm
Reduction factor r_{Al}		0.4
Reduction factor r_{Cu}		0.3
Reduction factor r_{304}		0.77
Reduction factor r_{Fe}		1
Reduction factor r_{Brass}		0.43
Output type		2-wire

Nominal ratings

Switching frequency	f	AC, 0 ... 30 Hz DC, 0 ... 100 Hz
Hysteresis	H	1 ... 10 typ. 5 %
Reverse polarity protection		reverse polarity tolerant
Short-circuit protection		pulsing
Voltage drop	U_d	≤ 5 V (typ. 2V) DC operation ≤ 8 V (typ. 3 V) AC operation
Momentary current (20 ms, 0.1 Hz)		0 ... 3000 mA

Design data

Operating current	I_L	5 ... 500 mA
Off-state current	I_r	≤ 1.5 mA
Time delay before availability	t_v	≤ 300 ms
Operating voltage indicator		LED, green
Switching state indicator		LED, yellow
Error indicator		flashes when overcurrent

Functional safety related parameters

MTTF _d	540 a
Mission Time (T _M)	20 a
Diagnostic Coverage (DC)	0 %

Electrical specifications

Rated operating voltage	U_e	24 ... 250 V DC / 24 ... 230 V AC
Operating voltage	U_B	20 ... 300 V DC / 20 ... 253 V AC

Ambient conditions

Ambient temperature	-25 ... 85 °C (-13 ... 185 °F)
Storage temperature	-25 ... 85 °C (-13 ... 185 °F)

Mechanical specifications

Connection type	terminal compartment
Information for connection	A maximum of two conductors with the same core cross section may be mounted on one terminal connection! tightening torque 1.2 Nm + 10 %
Core cross-section	up to 2.5 mm ²
Minimum core cross-section	without wire end ferrule 0.5 mm ² , with connector sleeves 0.34 mm ²
Maximum core cross-section	without wire end ferrule 2.5 mm ² , with connector sleeves 1.5 mm ²
Housing material	PA 6.6 / metal
Sensing face	PA 6.6
Housing base	plastic
Degree of protection	IP67

Compliance with standards and directives

Standard conformity	
Standards	EN 60947-5-2:2007 EN 60947-5-2/A1:2012 IEC 60947-5-2:2007 IEC 60947-5-2 AMD 1:2012

Approvals and certificates

Protection class	II
Rated insulation voltage	U_i 230 V
Rated impulse withstand voltage	U_{imp} 2.5 kV
UL approval	cULus Listed, General Purpose "For use in NFPA 79 Applications only" For overcurrent protection, install a fuse with a rated current of max. 3 A and at least 300 V AC/DC
CCC approval	Ue 75VDC - 250VDC Ue 75VAC - 230VAC

Dimensions

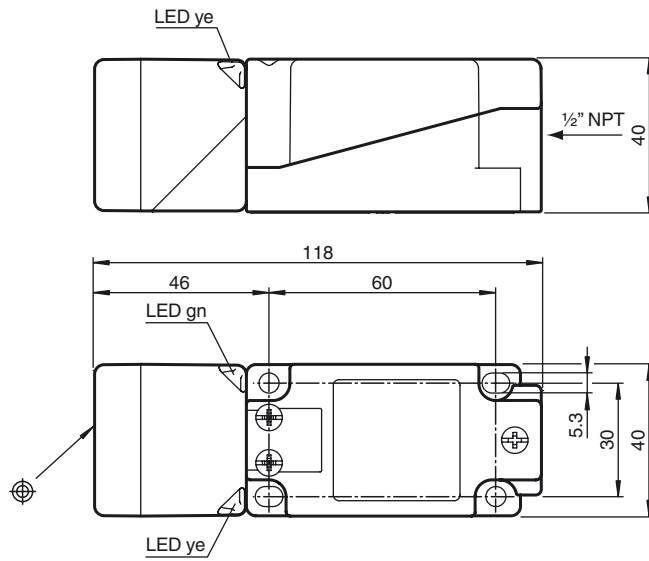

Electrical Connection

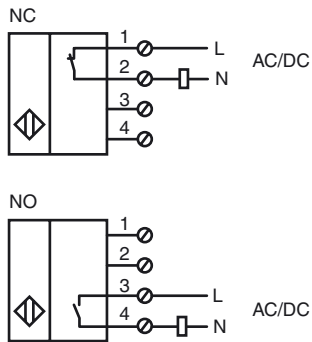

Note

The sensor is designed for individual operation. A series or parallel connection of sensors is not permissible.