

Read/write head

IUH-F192-V1-FR2-02



- Flexible UHF read/write head with long range for use worldwide
- Ready-made PLC function blocks designed for quick and easy system integration
- Compact and robust housing for harsh industrial environments
- Switchable antenna polarization guarantees reliable tag detection and enhances process flow
- Multi-tag reading of up to 200 tags increases productivity
- For connection to IDENTControl control interface

Read/write head for IDENTControl, USA and Argentina



Function

The IUH-F192-V1-FR2-02 read/write head operates in the UHF frequency range and is optimized for use in industrial applications involving greater distances. The device reads and writes passive tags according to EPC Generation 2 (ISO/IEC 18000-63). The read/write head can be operated in the USA, Canada and Mexico. The read/write head complies with the respective radio regulations. Wide range of options supported for filtering data. The read/write head is connected to the IDENTControl interface using an M12 connector. The user can monitor the status of the read/write head using the integrated LEDs. The read/write head has a typical detection range of approx. 3 meters; this range is determined by the tag used and can be changed by adjusting the transmission power. Other influencing factors are the application specific setup and surrounding materials, particularly metal. The read and write distances measured under ideal conditions can be found in a separate document. For the actual read and write distances under real conditions, the combination of read/write head and tag must be tested in the intended application.

Dimensions

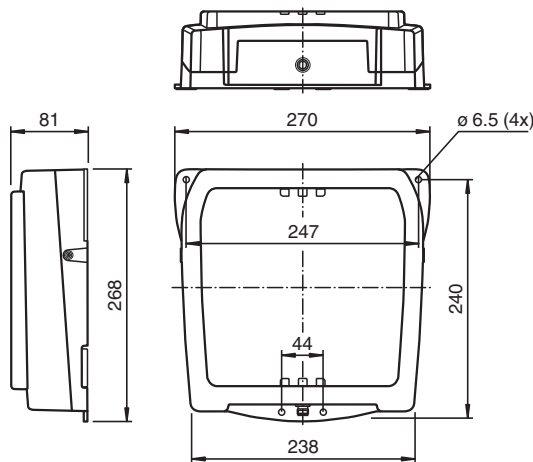

Technical Data

General specifications

Operating frequency	902 MHz ... 928 MHz: USA, Argentina Transmission licenses for other countries on request
Emitted power	10 ... 4000 mW EIRP adjustable
Operating distance	typ. 4 m

Functional safety related parameters

MTTF _d	128 a
-------------------	-------

Indicators/operating means

LED green	Power on
-----------	----------

Release date: 2020-03-27 Date of issue: 2020-03-27 Filename: 256083_eng.pdf

Refer to "General Notes Relating to Pepperl+Fuchs Product Information".

Pepperl+Fuchs Group
www.pepperl-fuchs.com

USA: +1 330 486 0001
fa-info@us.pepperl-fuchs.com

Germany: +49 621 776 1111
fa-info@de.pepperl-fuchs.com

Singapore: +65 6779 9091
fa-info@sg.pepperl-fuchs.com

PF PEPPERL+FUCHS

Technical Data

LED yellow		Read/write operation successful
LED blue		Transmission mode
Electrical specifications		
Power consumption	P_0	≤ 10 W
Supply		from the IDENTControl
Compliance with standards and directives		
Standard conformity		
Electromagnetic compatibility		EN 301489-1 V1.9.2:2011 EN 301489-3 V1.4.1:2003
Safety		IEC 60950-1:2005/A1:2009 (modified)
Degree of protection		EN 60529:2000
Approvals and certificates		
UL approval		UL 61010-1 3rd Edition CSA C22.2 NO. 61010-1-12 3rd Edition (EN 60950-, EN 60529 and IP67 are not included)
FCC approval		This device complies with part 15 of the FCC rules. Operation is subject to the following two conditions: (1) This device may not cause harmful interference, and (2) This device must accept any interference received, including interference that may cause undesired operation. Caution: Changes or modifications not expressly approved by the party responsible for compliance could void the user's authority to operate the equipment.
IC approval		This device complies with Industry Canada licence-exempt RSS standard(s) and with part 15 of the FCC Rules. Operation is subject to the following two conditions: (1) this device may not cause interference, and (2) this device must accept any interference, including interference that may cause undesired operation of the device. Le présent appareil est conforme aux CNR d'Industrie Canada applicables aux appareils radio exempts de licence. L'exploitation est autorisée aux deux conditions suivantes : (1) l'appareil ne doit pas produire de brouillage, et (2) l'utilisateur de l'appareil doit accepter tout brouillage radioélectrique subi, même si le brouillage est susceptible d'en compromettre le fonctionnement.
Radio approval		USA: FCC IREIUH-F192-V1
Ambient conditions		
Ambient temperature		-25 ... 70 °C (-13 ... 158 °F)
Storage temperature		-40 ... 85 °C (-40 ... 185 °F)
Mechanical specifications		
Degree of protection		IP67
Connection		connector M12 x 1
Material		
Housing		PA 6
Base		diecast aluminum
Mass		approx. 3000 g

Connection

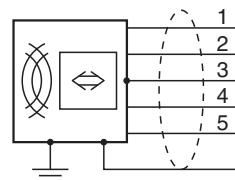
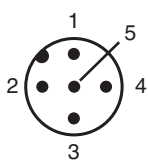











+
A
-
B
do not connect
Shield

Accessories

	IUC76-34-M-FR2	Data carrier
---	-----------------------	--------------

Accessories

	IUC76-50-FR2	Data carrier
	IUC76-F157-T17-M-FR2	Data carrier for standard applications
	IUC76-F157-T18-M-FR2	Data carrier for paint shop applications
	IUC76-F157-T19-M-FR2	Data carrier for autoclave applications
	IUC76-28L90-M-FR2 25pcs	Data carrier
	IUC77-25L100-GBL 1000pcs	Data carrier
	IUZ-MH13	Mounting bracket for wall mounting
	IUZ-MH15	Mounting aid for round steel \varnothing 12 mm or sheet 1.5 mm ... 3 mm
	V1-G-2M-PUR-ABG-V1-W	Connecting cable, M12 to M12, PUR cable 4-pin, shielded
	V1-G-5M-PUR-ABG-V1-W	Connecting cable, M12 to M12, PUR cable 4-pin, shielded
	V1-G-10M-PUR-ABG-V1-W	Connecting cable, M12 to M12, PUR cable 4-pin, shielded

Function

This product is a wireless device and may be operated only in the country for which a transmission license exists. Information regarding transmission licenses can be found on the datasheet for the product. If a product is released to a customer in a country for which there is no transmission license, the product may be operated only in the country for which a transmission license exists.

If a product does not correspond to the legal requirements in force in the EU but is released to a purchaser within the EU, the product is intended for use solely in the destination country of the end customer outside of the EU for which a transmission license exists. The product may therefore under no circumstances be used directly by the purchaser or released to third parties for the purpose of distribution, application or use on the market within the EU as part of a commercial activity.

In the event of an infringement, the purchaser is obliged to indemnify the supplier against any resulting damages, costs, penalty payments and other expenses.

Safety Information

This equipment has been tested and found to comply with the limits for a Class A digital device, pursuant to part 15 of the FCC Rules. These limits are designed to provide reasonable protection against harmful interference when the equipment is operated in a commercial environment. This equipment generates, uses, and can radiate radio frequency energy and, if not installed and used in accordance with the instruction manual, may cause harmful interference to radio communications. Operation of this equipment in a residential area is likely to cause harmful interference in which case the user will be required to correct the interference at his own expense.