



Model Number

V15-G-BK2M-PUR-U-V15-W

Connecting cable, M12 to M12, PUR cable 5-pin

Features

- Knurled nut suitable for tool assembly
- Immunity to vibration, with mechanical latching
- Gold plated contacts
- Degree of protection IP67 / IP68 / IP69K
- Raw cable with cURus approval
- UL Recognized Component
- Flame resistant cable
- Resistant to microbes and hydrolysis
- Halogen-free
- Suitable for drag chains

Dimensions

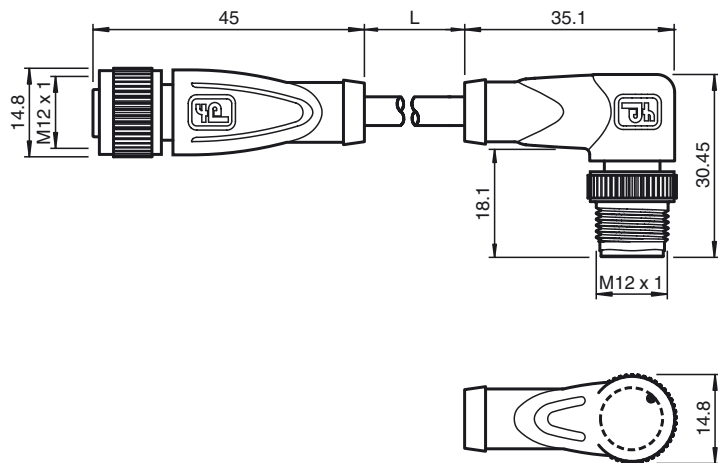

Technical data

General specifications

Number of pins	5
Connection 1	socket
Construction type 1	straight
Threading 1	M12
Connection 2	Male connector
Construction type 2	right angle
Threading 2	M12
UL File Number	E231213

Electrical specifications

Operating voltage	U _B	max. 48 V AC / 60 V DC
Operating current	I _B	max. 4 A
Contact resistance		< 10 mΩ

Ambient conditions

Ambient temperature	Body: -40 ... 90 °C (-40 ... 194 °F) cable, fixed: -40 ... 80 °C (-40 ... 176 °F) cable, flexing: -25 ... 80 °C (-13 ... 176 °F)
Pollution degree	3

Mechanical specifications

Contact elements	spring-loaded contact socket
Pin diameter	1 mm
Degree of protection	IP67 / IP68 / IP69K
Cable code	Li 9Y 11Y 5 x 0.34
Material	
Contacts	CuSn / Au
Contact surface	Au
Body	TPU, black
Cable	PUR
Slotted nut	Diecast zinc
Sleeve connector	Diecast zinc
Core insulation	PP
Cable	extra-fine wire, flexible
Sheath diameter	Ø 4.8 mm
Bending radius	> 10 x cable diameter, moving > 5 x cable diameter, fixed
Color	black
Number of cores	5
Core cross-section	0.34 mm ²
Conductor construction	19 x 0.15 mm Ø
Length	L 2 m
Drag chain suitability	
Drag chain cycles	≥ 5000000
Motion velocity	≤ 3.3 m/s
Torsion cycles	≥ 1000000

Electrical connection

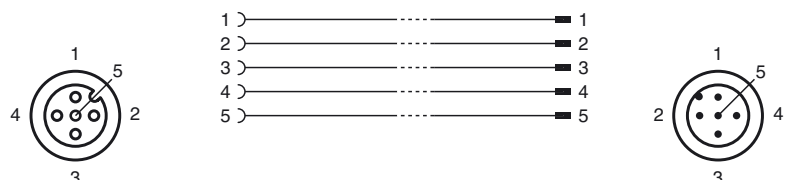

Release date: 2019-07-15 16:57 Date of issue: 2019-07-15 240778-100003_eng.xml

Refer to "General Notes Relating to Pepperl+Fuchs Product Information".

Torsional stress	± 180 °/m
Flammability	
Contact carrier	94 HB
Housing	94 V-2
Cable	FT2
Compliance with standards and directives	
Standard conformity	
Degree of protection	EN 60529:2000
Flammability	Body: UL 94 Line: UL 1581 Section 1061; IEC 60332-1-2:2004
Halogen-free	IEC 60754-1:1994
Specification	connector M12 x 1 : IEC 61076-2-101
Approvals and certificates	
UL approval	UL Recognized General purpose
Maximum permissible operating voltage	≤ 30 V
Maximum permissible ambient temperature	≤ 80 °C (≤ 176 °F)

Release date: 2019-07-15 16:57 Date of issue: 2019-07-15 240778-100003_eng.xml

Refer to "General Notes Relating to Pepperl+Fuchs Product Information".