

Schreib-/Lesestation

IQT1-18GM-IO-V1



- Arbeitsfrequenz 13,56 MHz
- IO-Link-Schnittstelle
- Konform mit ISO 15693
- Für FRAM-Transponder geeignet
- LEDs zur Funktionsanzeige
- Schreib-/Lesekopf mit Gewinde M18 x 1
- Anschluss über Steckverbinder V1 (M12 x 1)
- Schutzart IP67
- Zum Anschluss an IO-Link-Master

Schreib-/Lesestation HF mit IO-Link gem. ISO 15693



Abmessungen

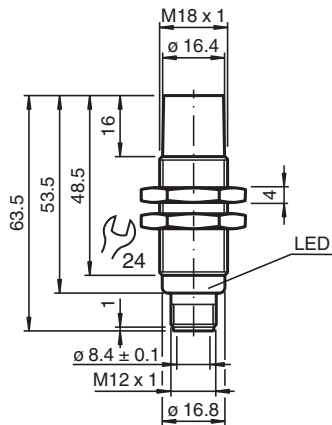

Technische Daten

Allgemeine Daten

Arbeitsfrequenz	13,56 MHz
Übertragungsrate	26 kBit/s
Erfassungsbereich	
Leseabstand	0 ... 50 mm
Schreibabstand	0 ... 50 mm
Breite	max. 45 mm
UL File Number	E87056

Kenndaten funktionale Sicherheit

MTTF _d	280 a
Gebrauchsdauer (T _M)	10 a
Diagnosedeckungsgrad (DC)	0 %

Anzeigen/Bedienelemente

LED rot/grün	grün leuchtend: Power on grün blinkend: IO-Link-Kommunikation rot/grün blinkend: IO-Link-Kommunikation gestört
--------------	--

Veröffentlichungsdatum: 2020-03-24 Ausgabedatum: 2020-03-27 Dateiname: 299927_ger.pdf

Beachten Sie „Allgemeine Hinweise zu Pepperl+Fuchs-Produktinformationen“.

Pepperl+Fuchs-Gruppe
www.pepperl-fuchs.com

USA: +1 330 486 0001
fa-info@us.pepperl-fuchs.com

Deutschland: +49 621 776 1111
fa-info@de.pepperl-fuchs.com

Singapur: +65 6779 9091
fa-info@sg.pepperl-fuchs.com

PEPPERL+FUCHS

Technische Daten

LED blau/gelb		blau: Schreib-/Leseversuch wird ausgeführt gelb: Datenträger erkannt
Elektrische Daten		
Bemessungsbetriebsspannung	U_e	20 ... 30 V DC , Welligkeit 10 % _{SS}
Leistungsaufnahme	P_0	≤ 2 W
Schnittstelle		
Schnittstellentyp		IO-Link
Protokoll		IO-Link V1.1
Zykluszeit		min. 4 ms
Modus		COM 3 (230.4 kBaud)
Prozessdatenbreite		32 Byte
SIO-Mode Unterstützung		nein
Richtlinienkonformität		
Funkanlagen		
Richtlinie 2014/53/EU		EN 301489-1 EN 301489-3 EN 300330 EN 62368-1 EN 50364
RoHS		
Richtlinie 2011/65/EU (RoHS)		EN 50581
Normenkonformität		
Schutzart		EN 60529
Kommunikationsschnittstelle		EN 61131-9
RFID		ISO/IEC 15693-2 ISO/IEC 15693-3 ISO/IEC 18000-3
Zulassungen und Zertifikate		
UL-Zulassung		cULus Listed, Class 2 Power Source, Type 1 enclosure
FCC-Zulassung		This device complies with part 15 of the FCC rules. Operation is subject to the following two conditions: (1) This device may not cause harmful interference, and (2) This device must accept any interference received, including interference that may cause undesired operation. Caution: Changes or modifications not expressly approved by the party responsible for compliance could void the user's authority to operate the equipment.
IC-Zulassung		This device complies with Industry Canada licence-exempt RSS standard(s) and with part 15 of the FCC Rules. Operation is subject to the following two conditions: (1) this device may not cause interference, and (2) this device must accept any interference, including interference that may cause undesired operation of the device. Le présent appareil est conforme aux CNR d'Industrie Canada applicables aux appareils radio exempts de licence. L'exploitation est autorisée aux deux conditions suivantes : (1) l'appareil ne doit pas produire de brouillage, et (2) l'utilisateur de l'appareil doit accepter tout brouillage radioélectrique subi, même si le brouillage est susceptible d'en compromettre le fonctionnement.
Funkzulassung		USA: FCC IREIQT118GMIO Kanada: IC 7037A-IQT118GMIO
Umgebungsbedingungen		
Umgebungstemperatur		-25 ... 70 °C (-13 ... 158 °F)
Lagertemperatur		-40 ... 85 °C (-40 ... 185 °F)
Mechanische Daten		
Schutzart		IP67
Anschluss		Steckverbinder M12 x 1
Material		
Gehäuse		PBT/Edelstahl
Vergussmasse/Härter		CY 221/HY 2966
Montage		nicht bündig
Abstand zwischen zwei Köpfen		≥ 80 mm
Masse		ca. 25 g

Veröffentlichungsdatum: 2020-03-24 Ausgabedatum: 2020-03-27 Dateiname: 299927_ger.pdf

Beachten Sie „Allgemeine Hinweise zu Pepperl+Fuchs-Produktinformationen“.

 Pepperl+Fuchs-Gruppe
www.pepperl-fuchs.com

 USA: +1 330 486 0001
fa-info@us.pepperl-fuchs.com

 Deutschland: +49 621 776 1111
fa-info@de.pepperl-fuchs.com

 Singapur: +65 6779 9091
fa-info@sg.pepperl-fuchs.com





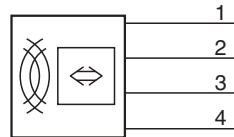
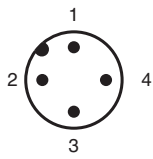











 **PEPPERL+FUCHS**

Anschluss



+
n.c.
-
C/Q

Zubehör

	ICE1-8IOL-G60L-V1D	Ethernet-IO-Link-Modul mit 8 Ein-/Ausgängen
	IO-Link-Master02-USB	IO-Link Master, Versorgung über USB-Port oder separate Spannungsversorgung, Anzeige-LEDs, M12-Stecker für Sensoranschluss
	V1-G-0,3M-PVC-V1-G	Verbindungskabel, M12 auf M12, PVC-Kabel 4-polig
	V1-G-5M-PVC-V1-G	Verbindungskabel, M12 auf M12, PVC-Kabel 4-polig
	V1-G-10M-PVC-V1-G	Verbindungskabel, M12 auf M12, PVC-Kabel 4-polig
	IQC21-8 10pcs	Datenträger
	IQC21-10 10pcs	Datenträger
	IQC21-12.4 10pcs	Datenträger
	IQC21-16 50pcs	Datenträger
	IQC21-30 25pcs	Datenträger
	IQC21-50F-T10	Datenträger
	IQC21-58	Datenträger
	IQC22-22-T9 50pcs	Datenträger
	IQC33-20 50pcs	Datenträger
	IQC33-30 25pcs	Datenträger
	IQC33-50 25pcs	Datenträger

Veröffentlichungsdatum: 2020-03-24 Ausgabedatum: 2020-03-27 Dateiname: 299927_ger.pdf

Beachten Sie „Allgemeine Hinweise zu Pepperl+Fuchs-Produktinformationen“.

 Pepperl+Fuchs-Gruppe
www.pepperl-fuchs.com

 USA: +1 330 486 0001
fa-info@us.pepperl-fuchs.com

 Deutschland: +49 621 776 1111
fa-info@de.pepperl-fuchs.com

 Singapur: +65 6779 9091
fa-info@sg.pepperl-fuchs.com

 **PEPPERL+FUCHS**

Sicherheitsinformation

This equipment has been tested and found to comply with the limits for a Class A digital device, pursuant to part 15 of the FCC Rules. These limits are designed to provide reasonable protection against harmful interference when the equipment is operated in a commercial environment. This equipment generates, uses, and can radiate radio frequency energy and, if not installed and used in accordance with the instruction manual, may cause harmful interference to radio communications. Operation of this equipment in a residential area is likely to cause harmful interference in which case the user will be required to correct the interference at his own expense.

Veröffentlichungsdatum: 2020-03-24 Ausgabedatum: 2020-03-27 Dateiname: 299927_ger.pdf

Beachten Sie „Allgemeine Hinweise zu Pepperl+Fuchs-Produktinformationen“.

Pepperl+Fuchs-Gruppe
www.pepperl-fuchs.com

USA: +1 330 486 0001
fa-info@us.pepperl-fuchs.com

Deutschland: +49 621 776 1111
fa-info@de.pepperl-fuchs.com

Singapur: +65 6779 9091
fa-info@sg.pepperl-fuchs.com

 **PEPPERL+FUCHS**