



Model Number

NRB15-30GM50-E2-IO-C-V1

Features

- 15 mm flush
- Reduction factor = 1
- Magnetic field resistant
- Weld Immune
- IO-link interface for service and process data
- Switch point mode or window mode can be set
- Switching function, stability alarm and pulse extension can be set

Description

Reduction factor 1 sensors reliably detect different metals with the same switch state. The integrated IO-Link interface enables clear identification of the sensor and diagnosis of the sensor condition. When using the sensor, parameters and operating modes can be optimally configured specifically for the intended application. In addition to setting the switching function and a pulse extension, the user can select either switch point mode or window mode in combination with a stability alarm. In switch point mode, the stability alarm signals the detection of an object in the area between the assured operating distance and operating distance s_n . In window mode, it signals the detection of an object below the window between operating distance s_n and the nearest operating distance. A stability alarm is displayed to the user via a flashing LED and process data.

Accessories

IO-Link-Master02-USB

IO-Link master, supply via USB port or separate power supply, LED indicators, M12 plug for sensor connection

BF 30

Mounting flange, 30 mm

EXG-30

Quick mounting bracket with dead stop

V1-G

Female connector, M12, 4-pin, field attachable

V1-W

Female connector, M12, 4-pin, field attachable

V1-G-2M-PUR

Female cordset, M12, 4-pin, PUR cable

V1-W-2M-PUR

Female cordset, M12, 4-pin, PUR cable

Technical Data

General specifications

Switching function		Normally open/closed (NO/NC) programmable
Output type		PNP
Rated operating distance	s_n	15 mm (factory setting)
Near operating distance		10 mm (can be activated by software)
Installation		flush
Output polarity		DC
Assured operating distance	s_a	0 ... 12.15 mm
Reduction factor r_{Al}		1
Reduction factor r_{Cu}		1
Reduction factor r_{304}		1
Reduction factor r_{St37}		1
Output type		3-wire

Nominal ratings

Operating voltage	U_B	10 ... 30 V DC
Switching frequency	f	0 ... 600 Hz (switch point mode) 0 ... 25 Hz (window mode, switch point mode with stability alarm)
Hysteresis	H	typ. 3 %
Reverse polarity protection		reverse polarity protected
Short-circuit protection		pulsing
Voltage drop	U_d	≤ 0.5 V
Operating current	I_L	0 ... 200 mA
Off-state current	I_r	0 ... 0.5 mA typ. 60 μ A at 25 °C
No-load supply current	I_0	≤ 15 mA
Time delay before availability	t_v	≤ 150 ms
Constant magnetic field	B	200 mT
Alternating magnetic field	B	200 mT
Status indicator		Multihole-LED, yellow

Functional safety related parameters

MTTF _d	362 a
Mission Time (T _M)	20 a
Diagnostic Coverage (DC)	0 %

Interface

Interface type	IO-Link (via C/Q = pin 4)
Transfer rate	COM 2 (38.4 kBaud)
IO-Link Revision	1.1
Min. cycle time	2.3 ms
Process data width	Process data input (control system side): 2 Bit Process data output (control system side): none
SIO mode support	yes
Device ID	0x201113 (2101523)
Compatible master port type	A

Ambient conditions

Ambient temperature	-25 ... 70 °C (-13 ... 158 °F)
Storage temperature	-40 ... 85 °C (-40 ... 185 °F)

Mechanical specifications

Connection type	Connector plug M12 x 1 , 4-pin
Housing material	Brass, PTFE coated
Sensing face	PPS
Degree of protection	IP67
Mass	156 g

Factory settings

Default setting	operating mode = switch point mode with stability alarm switching function = Normally open (NO) switching distance = 15 mm
-----------------	--

General information

Scope of delivery	2 self locking nuts in scope of delivery
-------------------	--

Compliance with standards and directives

Standard conformity	
Standards	EN 60947-5-2:2007 EN 60947-5-2/A1:2012 IEC 60947-5-2:2007 IEC 60947-5-2 AMD 1:2012

Approvals and certificates

Protection class	II
Rated insulation voltage	U_i 60 V
Rated impulse withstand voltage	U_{imp} 800 V
UL approval	cULus Listed, General Purpose Class 2 power source
CCC approval	CCC approval / marking not required for products rated ≤ 36 V

Dimensions

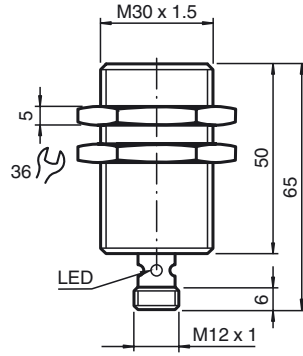

Electrical Connection

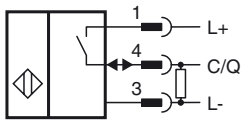

Pinout

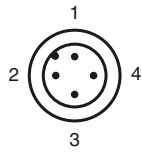

Wire colors in accordance with EN 60947-5-2

1	BN	(brown)
2	WH	(white)
3	BU	(blue)
4	BK	(black)

Switching output modes

Switch point mode at rated operating distance s_n

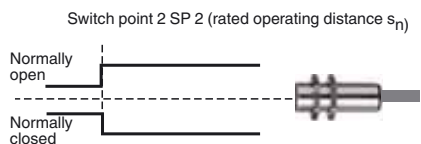

Switch point mode with near operating distance

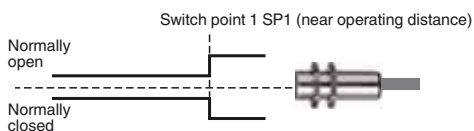

Window mode

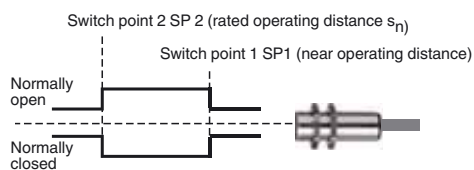

Stability alarm

Switch point mode with stability alarm (factory default)

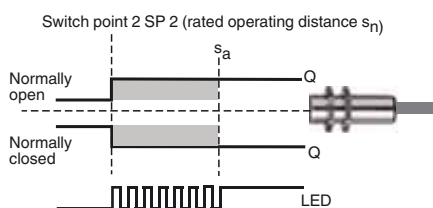

Window mode with stability alarm

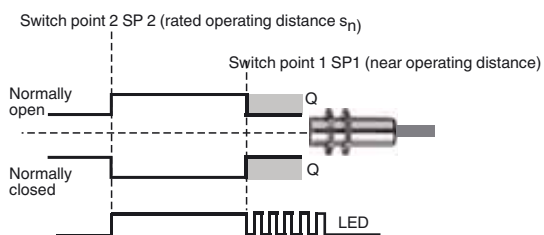

Release date: 2019-06-05 09:47 Date of issue: 2019-06-05 306533-0009_eng.xml