

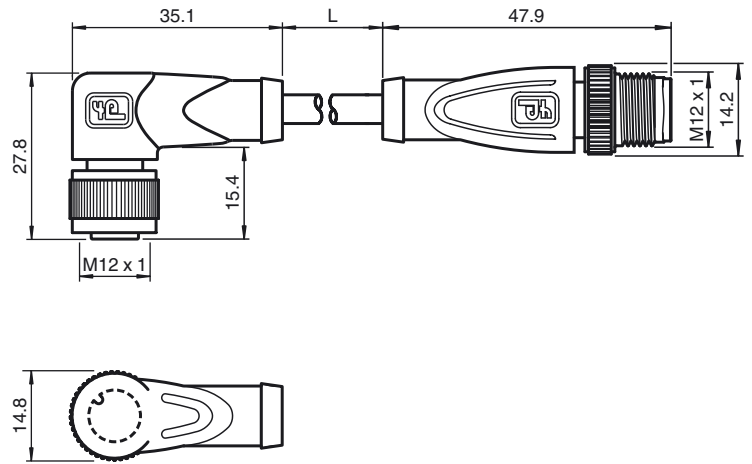

**Dimensions**



**Model Number**

**V15-W-3M-PUR-V15-G**

Connecting cable, M12 to M12, PUR cable 5-pin

**Features**

- Knurled nut suitable for tool assembly
- Immunity to vibration, with mechanical latching
- Gold plated contacts
- Degree of protection IP67 / IP68 / IP69K
- Halogen-free
- Suitable for 2-, 3- and 4-wire technology

**Technical data**

**General specifications**

Number of pins	5
Connection 1	socket
Construction type 1	right angle
Threading 1	M12
Connection 2	Male connector
Construction type 2	straight
Threading 2	M12

**Electrical specifications**

Operating voltage	$U_B$	max. 48 V AC / 60 V DC
Operating current	$I_B$	max. 4 A
Volume resistance		< 5 m $\Omega$

**Ambient conditions**

Ambient temperature	-25 ... 100 °C (-13 ... 212 °F) for temperatures over 80 °C (176 °F) reduced elongation at tear
Pollution degree	3

**Mechanical specifications**

Contact elements	spring-loaded contact socket
Pin diameter	1 mm
Degree of protection	IP67 / IP68 / IP69k
Material	
Contacts	CuSn / Au
Contact surface	Au
Body	TPU, black
Cable	PUR
Slotted nut	Diecast zinc
Sleeve connector	Diecast zinc
Core insulation	PP
Cable	fine-strand, flexible
Sheath diameter	Ø4.8 mm
Bending radius	> 10 x cable diameter, moving
Color	grey
Cores	5 x 0.34 mm <sup>2</sup>
Conductor construction	19 x 0.15 mm Ø
Length	L 3 m
Flammability	
Contact carrier	94 V-2
Housing	94 V-2

**Compliance with standards and directives**

Standard conformity	
Specification	connector M12 x 1 : IEC 61076-2-101

**Electrical connection**

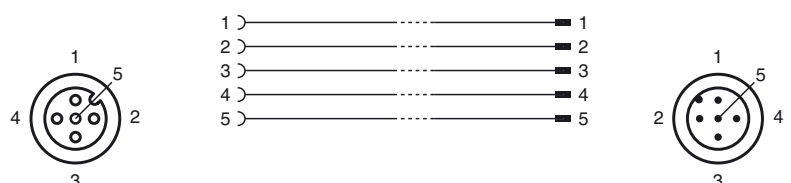

Release date: 2019-07-15 17:08 Date of issue: 2019-07-15 203271\_eng.xml