



Model Number

LC20-2-RB 230VAC

Loop detector
230 V AC

Features

- Sensor system for vehicle detection
- Complete control interface for inductive loops laid beneath the surface
- Reliable detection with long service life
- Boost function for increasing sensitivity
- Test function
- Version with 2 loop channels
- Version with direction detection

Product information

In combination with wire loops laid in the floor, loop detectors form a universal sensor system for detecting vehicles. When vehicles drive onto the loop, the resonance frequency changes. Intelligent automatic frequency selection (AFS) reduces setup time and simplifies the installation of complex multi-lane entrances. The evaluation process automatically and cyclically adjusts to the respective loop, so that changes in loop inductance due to temperature, humidity or component ageing are automatically compensated.

Dimensions

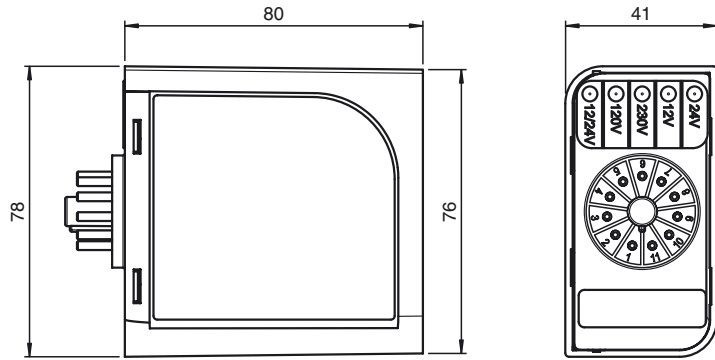

Electrical connection

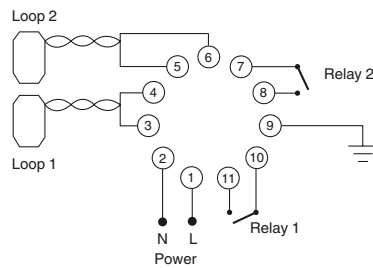

11-pole connector

Pos. No.	Function
1	L Power supply
2	N 230 V ±10% AC 50/60 Hz
3	Loop 1 Twist pair 3 + 4
4	Loop 1
5	Loop 2 Twist pair 5 + 6
6	Loop 2
7	NO relay contact 2
8	NO relay contact 2
9	Earth
10	NO relay contact 1
11	NO relay contact 1

Release date: 2019-11-13 10:55 Date of issue: 2019-11-18 70100659_eng.xml

Refer to "General Notes Relating to Pepperl+Fuchs Product Information".

Indicators/operating means

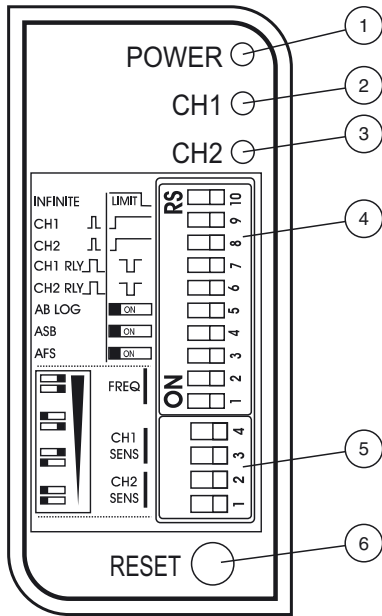

Pos. No.	Operating Elements
1	LED power supply
2	LED channel 1
3	LED channel 2
4	DIP switch
5	DIP switch channel 1 and 2
6	Reset button

Typical applications

- Park barrier control
- Safety loop
- Arming control
- Motorized gates and doors
- Industrial control systems

Detection area

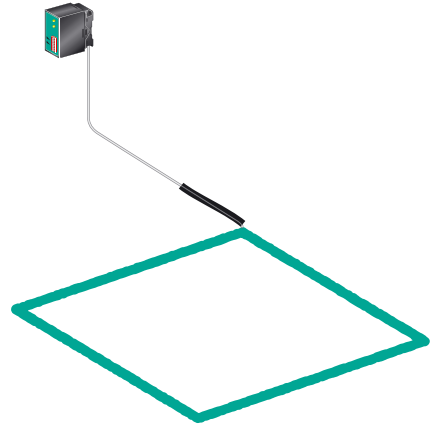

Technical data

General specifications

Adjustment range	Sensitivity $\Delta L/L$ 4x adjustable on the front panel 0.01 % ... 0.1 % with ASB overwrite option
Function principle	Inductive loop
Marking	CE
Presence time	One hour for 3 % $\Delta L/L$ and option for permanent presence
Self-tuning range	20 μ H ... 1500 μ H
Operating frequency	4x adjustable on the front panel: 12 kHz ... 80 kHz (with AFS switched off)
Operating mode	Pulsed and continuous signal

Indicators/operating means

Function indicator	1 x red LED: Power supply/Status , 2 x green LED: Channel status
Control elements	DIP-switch , Refer to the documentation for functions
Switching state	LED

Electrical specifications

Operating voltage	U_B	230 V AC \pm 15 %
No-load supply current	I_0	\emptyset 10.9 mA
Power consumption	P_0	\emptyset 2.5 VA

Input

Number of channels	2
--------------------	---

Output

Signal output	One configurable relay output per channel
Switching current	Relay outputs 1 A at 230 V AC
Pulse length	150 ms or 250 ms (selected via switch)
Response time	200 ms ... 300 ms

Directive conformity

Radio and telecommunication terminal equipment	2014/53/EU
--	------------

Ambient conditions

Operating temperature	-40 ... 70 °C (-40 ... 158 °F)
Storage temperature	-40 ... 70 °C (-40 ... 158 °F)
Relative humidity	max. 90 % , non-condensing

Mechanical specifications

Degree of protection	IP30
Connection	11-pin plug-in base
Material	
Housing	ABS, anthracite
Installation	11-pin plug-in base
Mass	250 g











Approvals and certificates

FCC approval	FCC 47 CFR Part 15
--------------	--------------------

Functional Principle

Loop detectors are control devices that are fully functional by connecting the supply voltage and an induction loop without the requirement of any additional devices. The induction wire loop laid in the floor has the inductance of a high-frequency oscillating circuit. When a vehicle drives or stands on the wire loop, the vehicle's metal parts change the frequency of the oscillating circuit. The loop detector evaluates this change and outputs it as a switching signal via volt-free relay contacts. The switching outputs are relay contacts with a high switching capacity. The spatial extent of the detection range can be varied by the size and shape of the induction loops used.

Programming

	Fail Secure	Fail Safe
Relay		
Loop not covered (No detection)		
Loop covered (Detection)		
Error		
Power off		

Release date: 2019-11-13 10:55 Date of issue: 2019-11-18 70100659_eng.xml

Refer to "General Notes Relating to Pepperl+Fuchs Product Information".

Presence Time: DIP Switch 10

The presence time setting determines how the detector tracks a detect. The following two selection modes are available: permanent presence and limited presence.

- Permanent presence mode: This setting maintains the presence of a vehicle over the loop by continuously compensating for all environmental changes.
- Limited presence mode: This setting limits the presence of a vehicle over the loop with the presence time being related to the size of the detect.

Typically, a 1 % Δ L/L will time out after approximately 1 hour.

Pulse on Detect or Presence on Detect: DIP Switch 9 - 8

The pulse relay offers the following settings:

- Pulse on detect: After 150 ms, the relay issues a pulse when detecting a vehicle drives on the loop.
- Presence on detect: Relay issues a pulse during the entire period a vehicle is detected.

This setting can be made for each channel respectively as indicated on the faceplate.

Fail-safe or Fail-secure: DIP Switch 7-6

Determine how the relay output of the presence relay is switched. Set the DIP switch to "Fail-Safe" or "Fail-Secure".

- Fail-safe setting: The output of detect is equivalent to powering off the sensor. This setting is used for access controls if persons are not to be locked out in the event of a power failure. A signal is output due to a valid detection situation or in the event of a power failure/ an error.
- Fail-secure setting: The output of non-detect is equivalent to powering off the sensor. This setting is used for access controls if persons should not be able to access the sensor in the event of a power failure. A signal is only issued due to a valid detection situation.

AB Logic: DIP Switch 5

Use AB Logic to count the cars going in a specified direction:

- 150 ms pulse output on Relay 1: Indicates a transition from loop 1 to loop 2 (classified as forwards).
- 150 ms pulse output on Relay 2: Indicates transition from loop 2 to loop 1 (classified as backwards).

Automatic Sensitivity Boost (ASB): DIP Switch 4

Use ASB to alter the undetect level of the sensor if required.

- ASB on: Boosts the sensitivity level to a maximum for detecting a vehicle, irrespective of the current sensitivity level maintained at this level during the entire presence of the vehicle over the loop. When the vehicle leaves the loop and the detection is lost, the sensitivity level reverts to the pre-selected level. ASB is used for vehicles with high beds or vehicles towing trailers to ensure detection over the entire length of the vehicle.
- ASB off: Sensitivity level remains unboosted during detection.

Automatic Frequency Selection (AFS): DIP Switch 3

Decide whether to use AFS or not.

- AFS on: The detector briefly evaluates all 5 frequency bands and selects the best operating frequency available. The tuning time with AFS switched on ranges between 5 s ... 20 s.
- AFS off: Select the frequency manually.

Manual Frequency Selection: DIP Switches 1-2

Use the frequency switches to set the operating frequency of the detector. If more than one detector is used at the same location, it is necessary to set a different frequency for each detector to avoid crosstalk (interference) between adjacent loops connected to different detectors. Make sure that the loops of the detectors used are at least 2 m apart between the adjacent ends. Set each detector used at the same location to a different frequency.

The loop interfaces of multi-channel detectors are designed in a way that the loops are immune to crosstalk.

DIP Switch 4	DIP Switch 3	Frequency
Right	Right	High frequency
Left	Right	Medium high frequency
Right	Left	Medium low frequency
Left	Left	Low frequency

Sensitivity: DIP Switches 1-4

The sensitivity of the detector determines the change in inductance required for detection. The loop detector offers up to 4 sensitivity settings. Sensitivity is defined as the change in inductance. The inductance of the loop detector ranges from 0.01 % ... 0.1 %, where 0.01 % corresponds to the highest sensitivity level.

DIP Switch 4	DIP Switch 3	Sensitivity
right	right	(0.01 %) - high sensitivity
left	right	(0.02 %) - medium high sensitivity
right	left	(0.05 %) - medium low sensitivity
left	left	(0.10 %) - low sensitivity

DIP Switch 2	DIP Switch 1	Sensitivity
right	right	(0.01 %) - high sensitivity
left	right	(0.02 %) - medium high sensitivity
right	left	(0.05 %) - medium low sensitivity
left	left	(0.10 %) - low sensitivity

Operation

Push Button for Detector Reset and for Accessing Power Failure Function

Use the multipurpose button either to reset the detector if required or to access the power failure function. The loop detector has a power failure function. In the event of a power failure, the function detects a present vehicle on the loop. This function is designed for fail-safe situations to maintain pulse output status and prevent pulse output failure in the event of a power failure.

Use the Reset push button in the following cases:

- Reset the detector.
- Switch the power failure function on/off.

The function of the reset push button depends on the duration of pushing it down (=holding time):

Operating element	Purpose	Holding time	Function description
Push button	Reset	3 s	Starts the reset of the detector.
	Show power fail state	10 s	Hold for 10 seconds, to analyze the state of the power fail. If LEDs are ON, the Power Fail Toggle is ON. If LEDs are OFF, the Power Fail Toggle is OFF.
	Power Fail Toggle	30 s	After 30 seconds the Power Fail Toggle is OFF if the LEDs turn OFF. If the LEDs turn ON after 30 seconds, the Power Fail Toggle is ON.