



### Model Number

**V1-W-E2-15M-PVC**

Cable socket, M12, LED, 3-pin, PVC cable

### Features

- Built-in LED, as operating and function indicator
- Knurled nut suitable for tool assembly
- Immunity to vibration, with mechanical latching
- Gold-plated and machined contacts
- Protection degree IP67 / IP68 / IP69K

### Dimensions

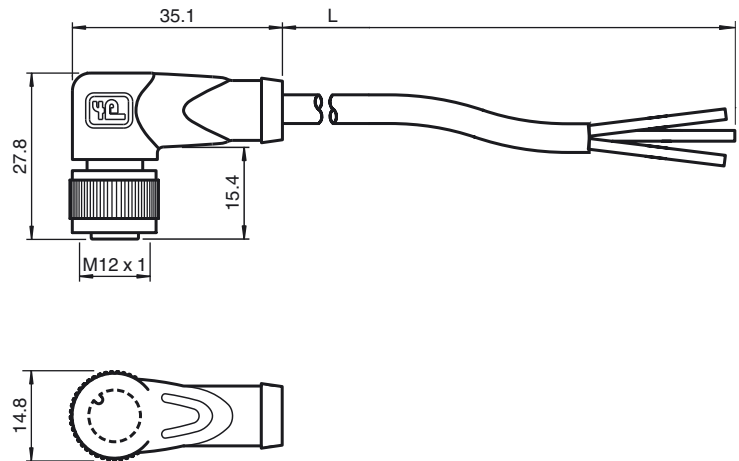

### Technical data

#### General specifications

Number of pins	3
Connection 1	socket
Construction type 1	right angle
Threading 1	M12
Connection 2	cable end

#### Indicators/operating means

LED green	Operating display
LED yellow	Functional display NO

#### Electrical specifications

Operating voltage	$U_B$	max. 24 V DC $\pm$ 15%
Operating current		max. 4 A
Volume resistance		< 5 m $\Omega$

#### Ambient conditions

Ambient temperature	Body: -40 ... 90 °C (-40 ... 194 °F) cable, flexing: -5 ... 70 °C (23 ... 158 °F) cable, fixed: -25 ... 70 °C (-13 ... 158 °F)
Pollution Degree	3

#### Mechanical specifications

Contact elements	spring-loaded contact socket
Pin diameter	1 mm
Protection degree	IP67 / IP68 / IP69k
Material	
Contacts	CuSn / Au
Contact surface	Au
Body	TPU, transparent
Cable	PVC
Slotted nut	Diecast zinc
Core insulation	PVC
Cable	fine-strand, flexible
Sheath diameter	$\varnothing$ 4.8 mm
Bending radius	> 10 x cable diameter, moving
Color	grey
Cores	3 x 0.34 mm <sup>2</sup>
Conductor construction	19 x 0.15 mm $\varnothing$
Length	L 15 m
Flammability	
Contact material	94 HB
Housing	94 V-2

### Electrical connection

