



Model Number

V1-W-N-25M-PUR

Female cordset, M12, 2-pin, NAMUR, PUR cable

Features

- Suitable for NAMUR technology
- Blue sheath
- Knurled nut suitable for tool assembly
- Immunity to vibration, with mechanical latching
- Gold plated contacts
- Degree of protection IP67 / IP68 / IP69K
- Suitable for routing intrinsically safe circuits in accordance with DIN EN 60079-14:2014

Dimensions

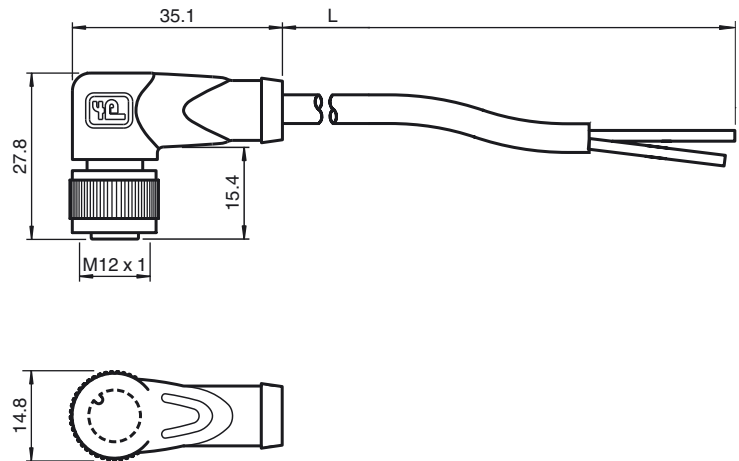

Technical data

General specifications

Number of pins	2
----------------	---

Electrical specifications

Operating voltage	U_B	max. 250 V AC/DC
Test voltage		> 500 V _{eff} AC
Operating current	I_B	max. 4 A
Contact resistance		< 10 mΩ
Inductance		0.55 mH / km
Capacitance		88.3 nF / km

Ambient conditions

Ambient temperature	Body: -40 ... 90 °C (-40 ... 194 °F) cable -25 ... 100 °C (-13 ... 212 °F)
---------------------	---

Pollution degree	3
------------------	---

Mechanical specifications

Contact elements	spring-loaded contact socket
Pin diameter	1 mm
Degree of protection	IP67 / IP68 / IP69k
Cable code	Li FY 11Y 2 x 0.34
Material	
Contacts	CuSn / Au
Contact surface	Au
Body	TPU, black
Cable	PUR
Slotted nut	Diecast zinc
Core insulation	PVC
Cable	extra-fine wire, flexible
Sheath diameter	Ø 4.8 mm
Bending radius	> 15 x cable diameter, moving > 10 x cable diameter, fixed
Color	blue
Cores	2 x 0.34 mm ²
Conductor construction	42 x 0.1 mm Ø
Length	L 25 m
Flammability	
Contact carrier	94 HB
Housing	94 V-2

Compliance with standards and directives

Standard conformity	
Degree of protection	EN 60529
Standards	IEC 61076-2-101

Electrical connection

