



Model Number

V15S-W-BK5M-PUR-U

Cable connector, M12, 5-pin, PUR cable

Features

- Knurled nut suitable for tool assembly
- Immunity to vibration, with mechanical latching
- Gold plated contacts
- Degree of protection IP67 / IP68 / IP69K
- Raw cable with cURus approval
- UL Recognized Component
- Flame resistant cable
- Resistant to microbes and hydrolysis
- Halogen-free
- Suitable for drag chains

Dimensions

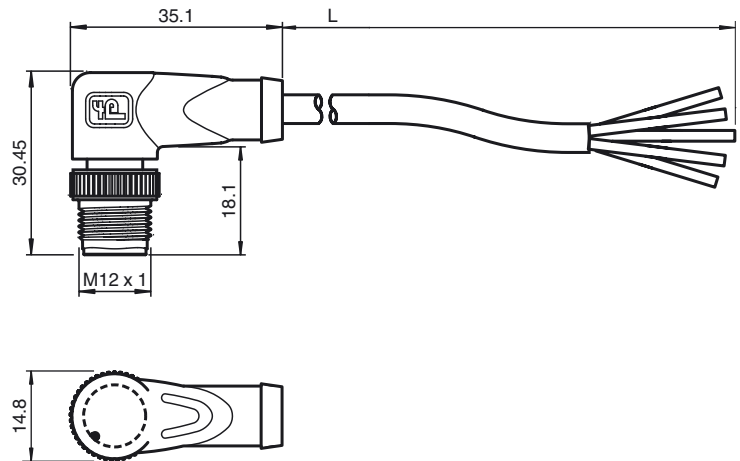

Technical data

General specifications

Number of pins	5
Connection 1	Male connector
Construction type 1	right angle
Threading 1	M12
Connection 2	cable end
UL File Number	E231213

Electrical specifications

Operating voltage	U_B	max. 48 V AC / 60 V DC
Operating current	I_B	max. 4 A
Contact resistance		< 10 m Ω

Ambient conditions

Ambient temperature	Body: -40 ... 90 °C (-40 ... 194 °F) cable, fixed: -40 ... 80 °C (-40 ... 176 °F) cable, flexing: -25 ... 80 °C (-13 ... 176 °F)
Pollution degree	3

Mechanical specifications

Pin diameter	1 mm
Degree of protection	IP67 / IP68 / IP69k
Cable code	Li 9Y 11Y 5 x 0.34
Material	
Contacts	CuSn / Au
Contact surface	Au
Body	TPU, black
Cable	PUR
Sleeve connector	Diecast zinc
Core insulation	PP
Cable	extra-fine wire, flexible
Sheath diameter	Ø4.8 mm
Bending radius	> 10 x cable diameter, moving > 5 x cable diameter, fixed
Color	black
Number of cores	5
Core cross-section	0.34 mm ²
Conductor construction	19 x 0.15 mm Ø
Length	L 5 m
Drag chain suitability	
Drag chain cycles	≥ 5000000
Motion velocity	≤ 3.3 m/s
Torsion cycles	≥ 1000000
Torsional stress	± 180 °/m
Flammability	
Contact carrier	94 HB
Housing	94 V-2

Electrical connection

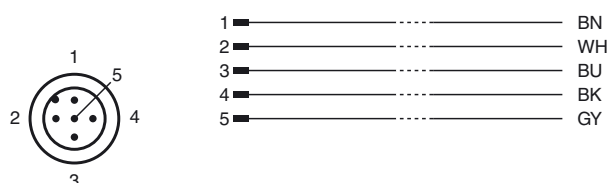

Cable	FT2
-------	-----

Compliance with standards and directives

Standard conformity

Degree of protection	EN 60529:2000
Flammability	Body: UL 94 Line: UL 1581 Section 1061; IEC 60332-1-2:2004
Halogen-free	IEC 60754-1:1994
Specification	connector M12 x 1 : IEC 61076-2-101

Approvals and certificates

UL approval	UL Recognized General purpose
Maximum permissible operating voltage	≤ 30 V
Maximum permissible ambient temperature	≤ 80 °C (≤ 176 °F)

Release date: 2019-07-15 17:01 Date of issue: 2019-07-15 240772-100011_eng.xml

Refer to "General Notes Relating to Pepperl+Fuchs Product Information".

Pepperl+Fuchs Group
www.pepperl-fuchs.comUSA: +1 330 486 0001
fa-info@us.pepperl-fuchs.comGermany: +49 621 776 1111
fa-info@de.pepperl-fuchs.comSingapore: +65 6779 9091
fa-info@sg.pepperl-fuchs.com **PEPPERL+FUCHS**