

Spec.
3.0

Model number

BW2087

PCI double master for 2 AS-Interface networks

Features

- V3.0-Master
- Connection to PCI bus
- 2 AS-Interface networks
- Simple installation
- PC-independent program processing
- Does not require any interrupts
- Up to 4 cards per PC
- Connectable watchdog
- Earth fault detection
- AS-Interface noise detection

Dimensions

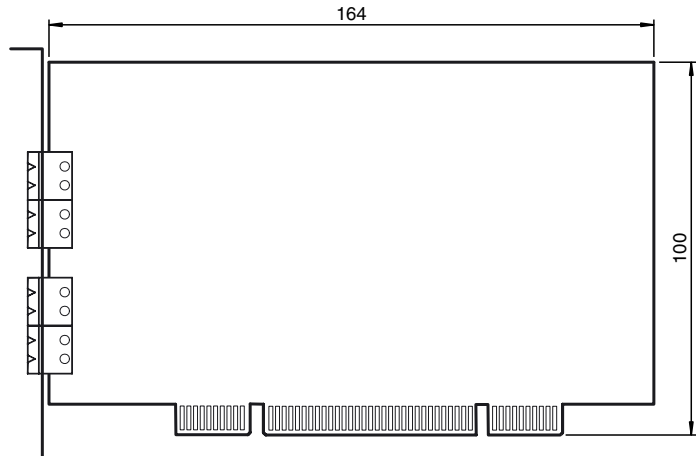

Electrical connection

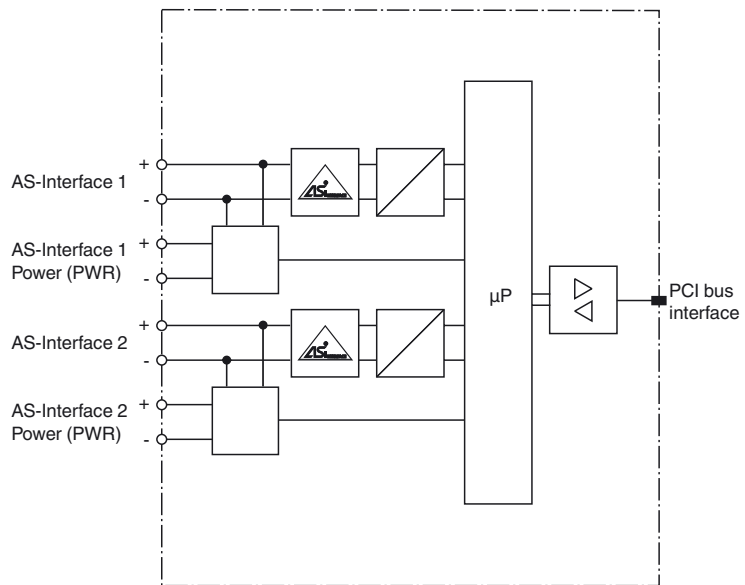

Indicating / Operating means

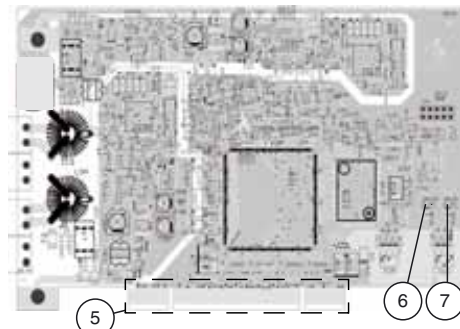
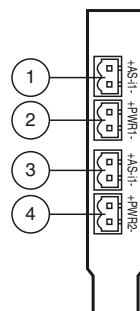

- | | | |
|--------------------------|--------------------------------------|----------------------|
| ① AS-Interface-Circuit 1 | ② AS-Interface-Circuit 1 Mains (PWR) | ⑤ PCI connection |
| ③ AS-Interface-Circuit 2 | ④ AS-Interface-Circuit 2 Mains (PWR) | ⑥ LED AS-Interface 1 |
| | | ⑦ LED AS-Interface 2 |

Release date: 2019-08-23 12:34 Date of issue: 2019-08-23 209343_eng.xml

Refer to "General Notes Relating to Pepperl+Fuchs Product Information".

Pepperl+Fuchs Group
www.pepperl-fuchs.com

USA: +1 330 486 0001
fa-info@us.pepperl-fuchs.com

Germany: +49 621 776 4411
fa-info@de.pepperl-fuchs.com

Singapore: +65 6779 9091
fa-info@sg.pepperl-fuchs.com

Technical data**General specifications**

AS-Interface specification	V3.0
PLC-Functionality	none
Earth fault detection	EFD integrated
EMC monitoring	integrated

Electrical specifications

Insulation voltage	U_i	≥ 500 V
Rated operating voltage	U_e	3.3 V DC/ 5 V DC and AS-Interface voltage
Rated operating current	I_e	≤ 100 mA from 3.3 supply, ≤ 300 mA from 5 V-supply, ≤ 70 mA from AS-Interface

Interface

Interface type	32 bit PCI bus interface
----------------	--------------------------

Directive conformity

Electromagnetic compatibility	
Directive 2014/30/EU	EN 62026-2:2013

Standard conformity

Degree of protection	EN 60529:2000
AS-Interface	EN 62026-2:2013

Ambient conditions

Ambient temperature	0 ... 55 °C (32 ... 131 °F)
Storage temperature	-25 ... 70 °C (-13 ... 158 °F)

Mechanical specifications

Degree of protection	IP20
Construction type	Short PCI card

Function

The BW2087 is an AS-Interface double master specially designed for operation on the PCI bus, a bus system integrated in every modern PC. The plug and play properties of hardware and drivers allow the simultaneous operation of up to 4 masters and render manual configuration superfluous. An efficient event control enables the card to exchange data more quickly and increases the performance of the system considerably as a result. An interrupt is not essential, but supports the event control on a system level, which further improves the performance of the system.

A switchable watchdog allows the monitoring of all communication between the AS-Interface master and the PC. If the PC operating system crashes, the AS-Interface master goes "offline" and all outputs are set as inactive. Extended diagnosis functions enable the localization of sporadically occurring configuration errors and the qualitative evaluation of AS-Interface communication.

Drivers are available for Windows 2000/XP.

PLC functionality

The gateway is also available with optional PLC functionality.

Accessories**VAZ-SW-ACT32**

Full version of the AS-I Control Tools including connection cable