

Read/write head IPH-FP7V4A

- Dual-LED for function display
- Stainless steel housing
- Resistant against cleaning material
- Connection via terminal compartment
- Degree of protection IP67 / IP68 / IP69K

LF read/write head for IDENTControl



Dimensions

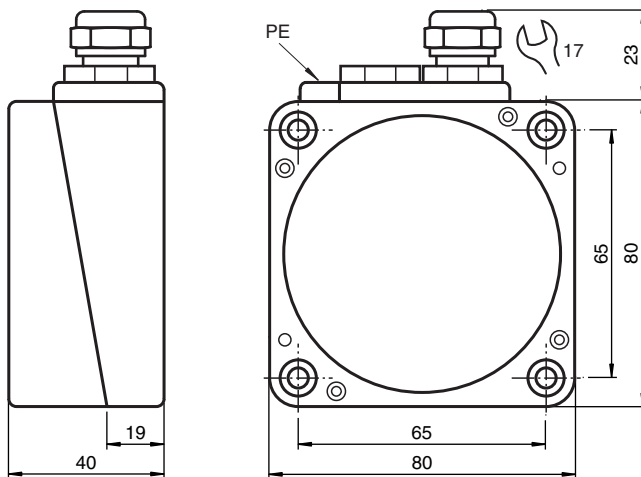

Technical Data

General specifications	
Operating frequency	125 kHz
Transfer rate	2 kBit/s
Sensing range	
Read distance	0 ... 100 mm
Write distance	0 ... 80 mm
Width	max. 80 mm
Operating distance	maximum: 100 mm
UL File Number	E87056
Functional safety related parameters	
MTTF _d	700 a
Mission Time (T _M)	10 a
Diagnostic Coverage (DC)	0 %
Indicators/operating means	
LED green/yellow	green: power on green flashing: read/write attempt performed yellow: data carrier detected

Release date: 2020-03-23 Date of issue: 2020-03-27 Filename: 196214_eng.pdf

Refer to "General Notes Relating to Pepperl+Fuchs Product Information".

Pepperl+Fuchs Group
www.pepperl-fuchs.com

USA: +1 330 486 0001
fa-info@us.pepperl-fuchs.com

Germany: +49 621 776 1111
fa-info@de.pepperl-fuchs.com

Singapore: +65 6779 9091
fa-info@sg.pepperl-fuchs.com

pepperl+fuchs



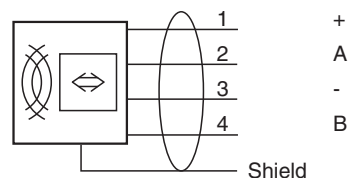

Technical Data

Electrical specifications		
Power consumption	P_0	$\leq 1.2 \text{ W}$
Supply		from the IDENTControl
Directive conformity		
Radio equipment		
Directive 2014/53/EU		EN 301489-1 EN 301489-3 EN 300330 EN 62368-1 EN 50364
RoHS		
Directive 2011/65/EU (RoHS)		EN 50581
Standard conformity		
Degree of protection		EN 60529
RFID		ISO/IEC 18000-2
Ambient conditions		
Ambient temperature		-25 ... 70 °C (-13 ... 158 °F)
Storage temperature		-40 ... 85 °C (-40 ... 185 °F)
Mechanical specifications		
Degree of protection		IP69K
Connection		terminal compartment, $\leq 2.5 \text{ mm}^2$ conductor csa
Material		
Housing		PBT
Base		stainless steel V4A
Encapsulation compound		Fermadur
Installation		
Distance between two heads		Multiplex on: $\geq 100 \text{ mm}$ Multiplex off: $\geq 550 \text{ mm}$
Mass		approx. 700 g

















Connection



Accessories

	IC-KP-B6-V15B	187.5 kBit/s
	IC-KP-B6-V15B	Control interface unit IDENTControlwith PROFIBUS DP interface
	IC-KP-B17-AIDA1	IDENTControl control interfaceWith Ethernet interface for TCP/IP, PROFINET, EtherNet/IP, and MODBUS TCP protocols
	IC-KP2-2HRX-2V1	Control interface unit IDENTControl Compactwith serial interface RS-232 and RS-485
	IC-KP2-2HRX-2V1	DP 1

Accessories

	IC-KP2-2HB6-V15B	Protocol
	IC-KP2-2HB6-V15B	Control interface unit IDENTControl Compactwith PROFIBUS DP interface
	IC-KP2-2HB17-2V1D	IDENTControl Compact control interfaceWith Ethernet interface for TCP/IP, PROFINET, EtherNet/IP, and MODBUS TCP protocols
	IC-KP2-2HB17-2V1D	1 MBit/s
	IC-KP2-2HB21-2V1D	Control interface unit IDENTControl Compactwith EtherCAT interface
	IPC02-12 50pcs	Code carrier
	IPC02-26-T6 10pcs	Code carrier
	IPC02-50P	Code carrier
	IPC03-C1 10pcs	Data carrier
	IPC03-12.4 10pcs	Data carrier
	IPC03-30P	Data carrier
	IPC03-50P	Data carrier
	IPC03-58	Data carrier
	V1-G-2M-PUR-ABG-V1-W	Connecting cable, M12 to M12, PUR cable 4-pin, shielded
	V1-G-5M-PUR-ABG-V1-W	Connecting cable, M12 to M12, PUR cable 4-pin, shielded
	V1-G-10M-PUR-ABG-V1-W	Connecting cable, M12 to M12, PUR cable 4-pin, shielded

Release date: 2020-03-23 Date of issue: 2020-03-27 Filename: 196214_eng.pdf

Refer to "General Notes Relating to Pepperl+Fuchs Product Information".

Pepperl+Fuchs Group
www.pepperl-fuchs.comUSA: +1 330 486 0001
fa-info@us.pepperl-fuchs.comGermany: +49 621 776 1111
fa-info@de.pepperl-fuchs.comSingapore: +65 6779 9091
fa-info@sg.pepperl-fuchs.com **PEPPERL+FUCHS**