



Model Number

V1-W-42-5M-PVC-V11-W

Double-ended cordset, M12 to M12, PVC cable, 3-pin, bridged

Features

- Pins 2 and 4 bridged
- Knurled nut suitable for tool assembly
- Immunity to vibration, with mechanical latching
- Gold plated contacts
- Halogen-free
- Protection degree IP67 / IP68 / IP69K

Dimensions

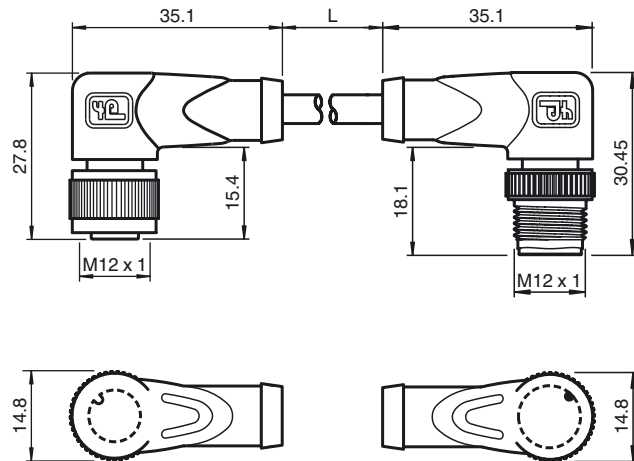

Technical data

General specifications

Number of pins	3
Connection 1	socket
Construction type 1	right angle
Threading 1	M12
Connection 2	Male connector
Construction type 2	right angle
Threading 2	M12

Electrical specifications

Operating voltage	U_B	max. 250 V AC/DC
Operating current		max. 4 A
Contact resistance		< 10 mΩ

Ambient conditions

Ambient temperature	Body: -40 ... 90 °C (-40 ... 194 °F) cable, fixed: -40 ... 70 °C (-40 ... 158 °F) cable, flexing: -5 ... 70 °C (23 ... 158 °F)
Pollution Degree	3

Mechanical specifications

Contact elements	spring-loaded contact socket
Pin diameter	1 mm
Protection degree	IP67 / IP68 / IP69k
Material	
Contacts	CuSn / Au
Contact surface	Au
Body	TPU, black
Cable	PVC
Slotted nut	Diecast zinc
Sleeve connector	Diecast zinc
Core insulation	PVC
Cable	fine-strand, flexible
Sheath diameter	Ø 4.8 mm
Bending radius	> 10 x cable diameter, moving
Color	grey
Cores	3 x 0.34 mm ²
Conductor construction	19 x 0.15 mm Ø
Length	L 5 m
Flammability	
Contact material	94 HB
Housing	94 V-2

Compliance with standards and directives

Standard conformity	
Protection degree	EN 60529:2000
Standards	IEC 61076-2-101:2008

Electrical connection

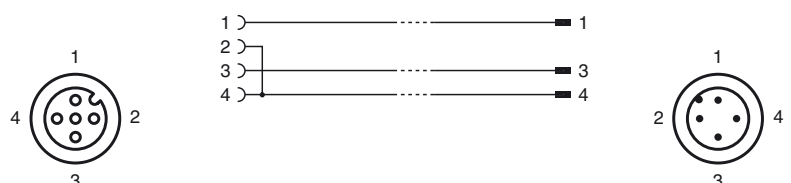

Release date: 2014-01-29 17:48 Date of issue: 2014-02-12 202974_eng.xml



Flammability

Grip: UL 94