

Read/write head

IQH1-F198-M-V1



- Operating frequency 13.56 MHz
- Conforms to ISO 15693
- Suitable for FRAM transponder
- Particularly flat construction
- Connection cable with V1 plug (M12 x 1)
- Degree of protection IP67
- Can be mounted on metal
- For connection to IDENTControl control interface

HF read/write head, ISO 15693, for IDENTControl



Dimensions

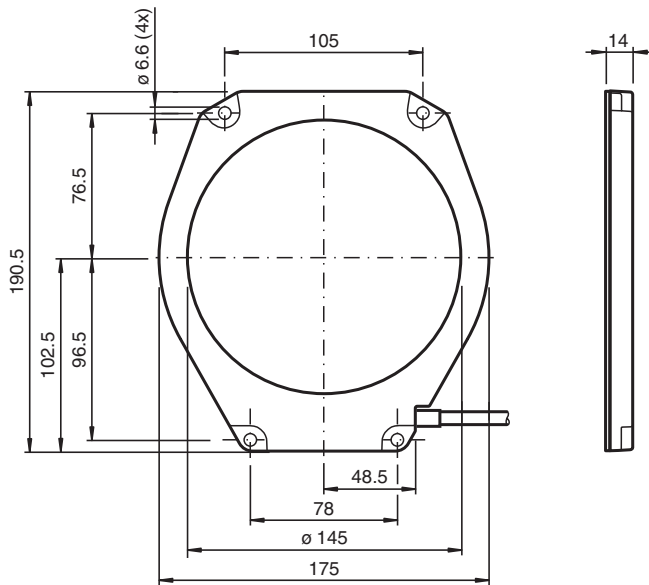

Technical Data

General specifications

Operating frequency	13.56 MHz
Transfer rate	26 kBit/s
Sensing range	
Read distance	0 ... 150 mm
Write distance	0 ... 150 mm
Width	max. 145 mm

Functional safety related parameters

MTTF _d	730 a
-------------------	-------

Release date: 2020-03-24 Date of issue: 2020-03-27 Filename: 289757_eng.pdf

Refer to "General Notes Relating to Pepperl+Fuchs Product Information".

Pepperl+Fuchs Group
www.pepperl-fuchs.com

USA: +1 330 486 0001
fa-info@us.pepperl-fuchs.com

Germany: +49 621 776 1111
fa-info@de.pepperl-fuchs.com

Singapore: +65 6779 9091
fa-info@sg.pepperl-fuchs.com

PEPPERL+FUCHS



Technical Data

Mission Time (T _M)		10 a
Diagnostic Coverage (DC)		0 %
Indicators/operating means		
LED green/yellow		green: power on green flashing: read/write attempt performed yellow: data carrier detected
Electrical specifications		
Power consumption	P ₀	≤ 1.3 W
Supply		from the IDENTControl
Directive conformity		
Radio equipment		
Directive 2014/53/EU		EN 301489-1 EN 301489-3 EN 300330 EN 62368-1 EN 50364
RoHS		
Directive 2011/65/EU (RoHS)		EN 50581
Standard conformity		
Degree of protection		EN 60529
RFID		ISO/IEC 15693-2 ISO/IEC 15693-3 ISO/IEC 18000-3
Ambient conditions		
Ambient temperature		-25 ... 70 °C (-13 ... 158 °F)
Storage temperature		-40 ... 85 °C (-40 ... 185 °F)
Mechanical specifications		
Degree of protection		IP67
Connection		connector M12 x 1
Material		
Housing		PA 6.6
Base		Aluminum
Encapsulation compound		WEVO 403FL/300
Installation		
Distance between two heads		Multiplex on: ≥ 100 mm Multiplex off: ≥ 150 mm
Mass		approx. 250 g
Cable length		20 cm

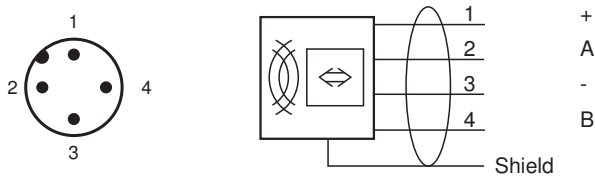

















Connection



Accessories

	IC-KP-B6-V15B	187.5 kBit/s
	IC-KP-B6-V15B	Control interface unit IDENTControlwith PROFIBUS DP interface

Accessories

	IC-KP-B17-AIDA1	IDENTControl control interfaceWith Ethernet interface for TCP/IP, PROFINET, EtherNet/IP, and MODBUS TCP protocols
	IC-KP2-2HRX-2V1	Control interface unit IDENTControl Compactwith serial interface RS-232 and RS-485
	IC-KP2-2HRX-2V1	DP 1
	IC-KP2-2HB6-V15B	Protocol
	IC-KP2-2HB6-V15B	Control interface unit IDENTControl Compactwith PROFIBUS DP interface
	IC-KP2-2HB17-2V1D	IDENTControl Compact control interfaceWith Ethernet interface for TCP/IP, PROFINET, EtherNet/IP, and MODBUS TCP protocols
	IC-KP2-2HB17-2V1D	1 MBit/s
	IC-KP2-2HB21-2V1D	Control interface unit IDENTControl Compactwith EtherCAT interface
	IQC21-30 25pcs	Data carrier
	IQC21-50F-T10	Data carrier
	IQC21-58	Data carrier
	IQC22-22-T9 50pcs	Data carrier
	IQC33-20 50pcs	Data carrier
	IQC33-30 25pcs	Data carrier
	IQC33-50 25pcs	Data carrier
	V1-G-2M-PUR-ABG-V1-W	Connecting cable, M12 to M12, PUR cable 4-pin, shielded
	V1-G-5M-PUR-ABG-V1-W	Connecting cable, M12 to M12, PUR cable 4-pin, shielded
	V1-G-10M-PUR-ABG-V1-W	Connecting cable, M12 to M12, PUR cable 4-pin, shielded