



Model Number

V19-W-BK2M-PUR-U

Female cordset, M12, 8-pin, PUR-cable

Features

- UL Recognized Component
- Knurled nut suitable for tool assembly
- Immunity to vibration, with mechanical latching
- Gold plated contacts
- Flame resistant cable
- Resistant to microbes and hydrolysis
- Halogen-free
- Degree of protection IP67 / IP68 / IP69K

Dimensions

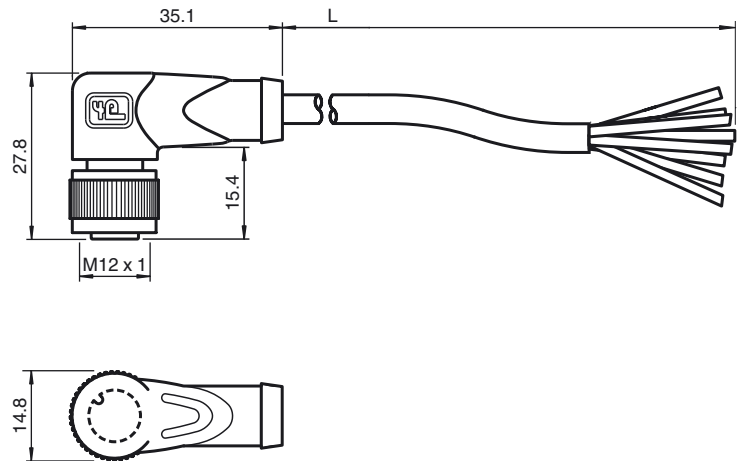

Technical data

General specifications

Number of pins	8
UL File Number	E231213

Electrical specifications

Operating voltage	U_B	max. 30 V AC/DC
Operating current	I_B	max. 2 A

Ambient conditions

Ambient temperature	-40 ... 90 °C (-40 ... 194 °F) cable, flexing: -20 ... 80 °C (-4 ... 176 °F) cable, fixed: -40 ... 80 °C (-40 ... 176 °F)
Pollution degree	3

Mechanical specifications

Contact elements	spring-loaded contact socket
Pin diameter	1 mm
Degree of protection	IP67 / IP68 / IP69k
Material	
Contacts	CuSn / Au
Contact surface	Au
Body	TPU, black
Cable	PUR
Slotted nut	Diecast zinc
Core insulation	PP
Cable	fine-strand, flexible
Sheath diameter	Ø 6 mm
Bending radius	> 10 x cable diameter, moving > 8 x cable diameter, fixed
Color	black
Number of cores	8
Core cross-section	0.25 mm ²
Conductor construction	14 x 0.15 mm Ø
Length	L 2 m
Flammability	
Contact carrier	94 HB
Housing	94 V-2

Approvals and certificates

UL approval	cURus AWM 20549 AWM I/II A/B 80°C 300V FT2 (cable)
-------------	--

Electrical connection

