

supplementary handle for door mounted rotary operator standard accessory for: 3VA2 250

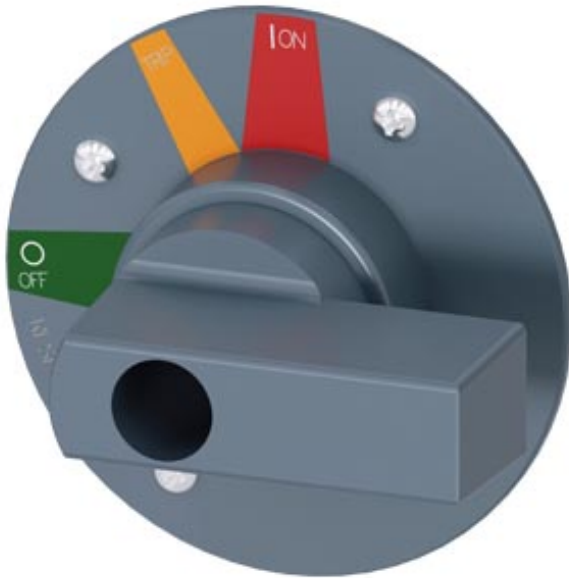

Model

Product brand name	SETRON
Product designation	Accessories
Product version	Additional handle for door-coupling rotary operating mechanism





General technical data

Protection class IP	IP20
---------------------	------

Mechanical Design

Height	70 mm
Width	70 mm
Depth	36 mm
Net weight	53 g

Certificates

General Product Approval	EMC	Declaration of Conformity	Test Certificates	Shipping Approval
Miscellaneous 	 RCM	 EG-Konf.	Type Test Certificates/Test Report	 LRS

other

[Manufacturer Declaration](#) [Miscellaneous](#)

Further information

Information- and Downloadcenter (Catalogs, Brochures,...)
<http://www.siemens.com/lowvoltage/catalogs>

Industry Mall (Online ordering system)
<https://mall.industry.siemens.com/mall/en/en/Catalog/product?mlfb=3VA9487-0GC01>

Service&Support (Manuals, Certificates, Characteristics, FAQs,...)
<https://support.industry.siemens.com/cs/ww/en/ps/3VA9487-0GC01>

Image database (product images, 2D dimension drawings, 3D models, device circuit diagrams, ...)
http://www.automation.siemens.com/bilddb/cax_en.aspx?mlfb=3VA9487-0GC01

CAX-Online-Generator
<http://www.siemens.com/cax>

Tender specifications
<http://www.siemens.com/specifications>

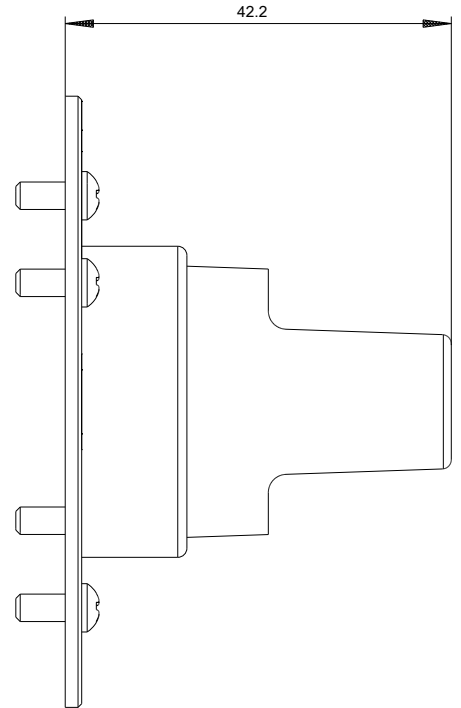
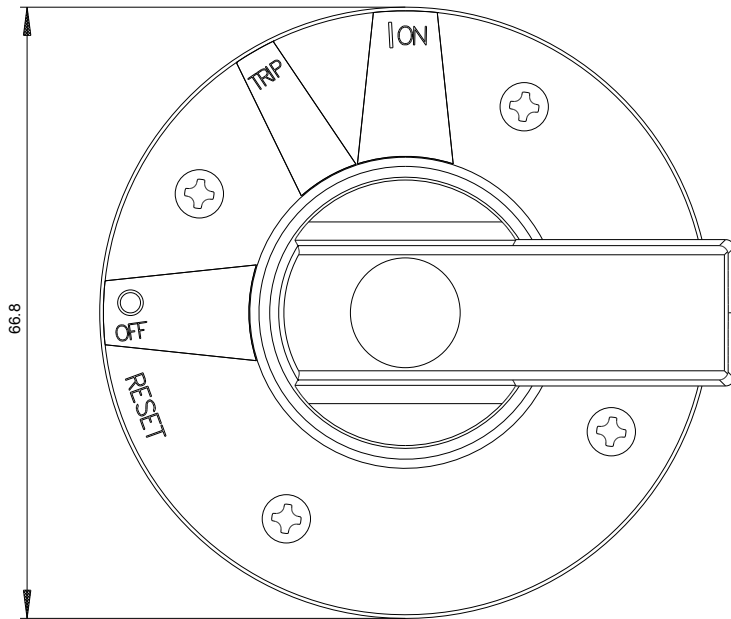

last modified:

05/06/2020