



Photoelectric sensors
W100 Laser, Photoelectric proximity sensor,
energetic

WT100L-E2141



Model Name > [WT100L-E2141](#)
Part No. > [6030706](#)



Illustration may differ

At a glance

- Standard miniature housing with M3 threaded mounting holes
- Laser emitter LED, class 1
- Energetic proximity sensor
- Switching frequency of 2000 Hz
- Light/dark switching via rotary switch

Your benefits

- Laser light spot combined with 2 kHz switching frequency ensures reliable detection of small objects, even at fast detection speeds
- Less contamination due to high optical operating reserve
- M3 threaded mounting holes provide easy installation
- Highly visible laser light simplifies installation



Features

Sensor/detection principle:	Photoelectric proximity sensor, energetic
Dimensions (W x H x D):	11 mm x 31 mm x 20 mm
Housing design (light emission):	Rectangular, Slim
Sensing range max.:	0 mm ... 450 mm ¹⁾
Sensing range:	0 mm ... 400 mm
Type of light:	Visible red light
Light source:	Laser ²⁾
Laser class:	1
Wave length:	650 nm
Light spot diameter (distance):	Ø 2 mm (400 mm)
Sensitivity adjustment:	Potentiometer, 270°
Focus adjustable:	-

¹⁾ Object with 90 % reflectance (referred to standard white DIN 5033) ²⁾ Average service life 50,000 h at T_A = +25 °C

Mechanics/electronics

Supply voltage:	10 V DC ... 30 V DC ¹⁾
Ripple:	± 10 % ²⁾
Power consumption:	≤ 30 mA ³⁾
Output type:	NPN, Light/dark-switching, manually selectable, open collector
Signal voltage NPN HIGH/LOW:	Approx. VS / < 1.8 V
Output current I _{max.} :	100

Response time:	< 0.25 ms ⁴⁾
Switching frequency:	2,000 ⁵⁾
Connection type:	Connector M8, 3-pin
Circuit protection:::	A, B, D ⁶⁾ 7) 8)
Weight:	10 g
Polarisation filter:	-
Housing material:	ABS/PC/POM
Optics material:	PMMA
Enclosure rating:	IP 65
Items supplied:	Stainless steel mounting bracket (1.4301/304) BEF-W100-A
Ambient operating temperature:	-10 °C ... 50 °C
Ambient storage temperature:	-40 °C ... 70 °C
UL File-No.:	CDRH-conform

1) Limit values, operation in short-circuit protected network max. 8 A 2) May not exceed or fall short of V_S tolerances 3) Without load 4) Signal transit time with resistive load 5) With light/dark ratio 1:1 6) A = V_S connections reverse-polarity protected 7) B = inputs and output reverse-polarity protected 8) D = outputs overcurrent and short-circuit protected

Dimensional drawing

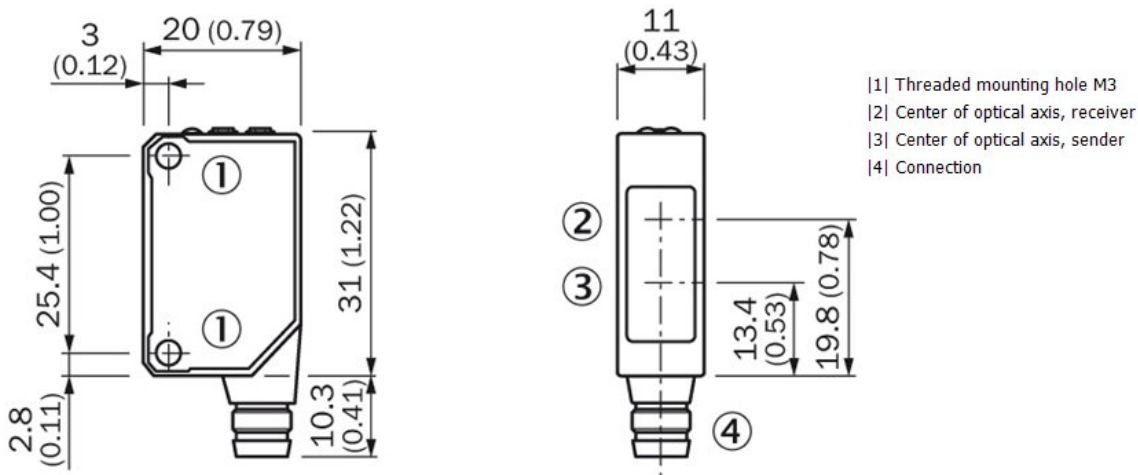

Adjustments possible

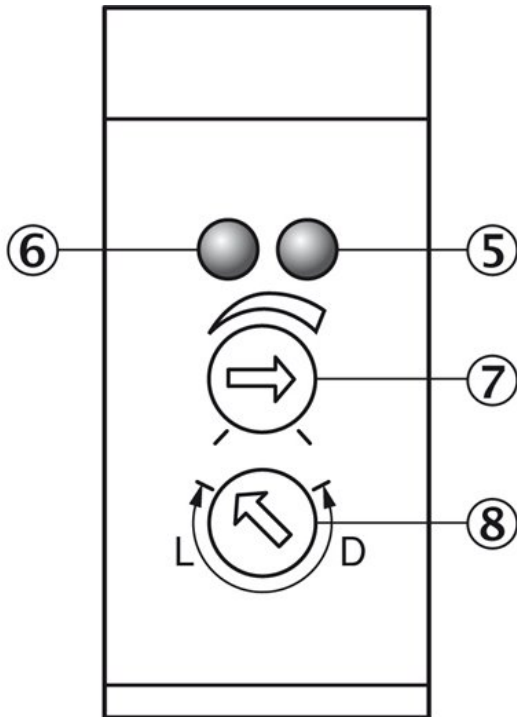

- |5| Orange LED indicator : switching output active
- |6| LED signal strength indicator green:power on
- |7| Sensing range adjustment: potentiometer, 5 turns
- |8| Light/ dark rotary switch L =
light switching, D = dark switching

Connection diagram

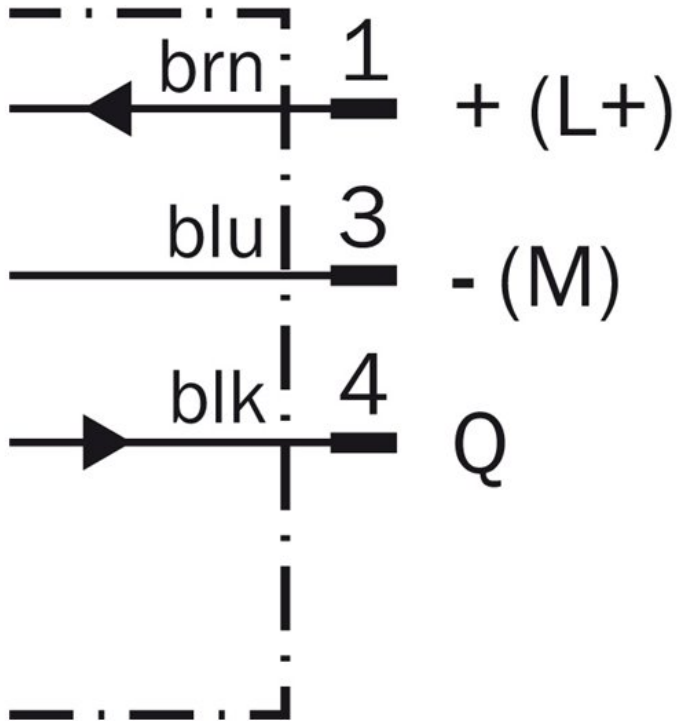

Characteristic curve

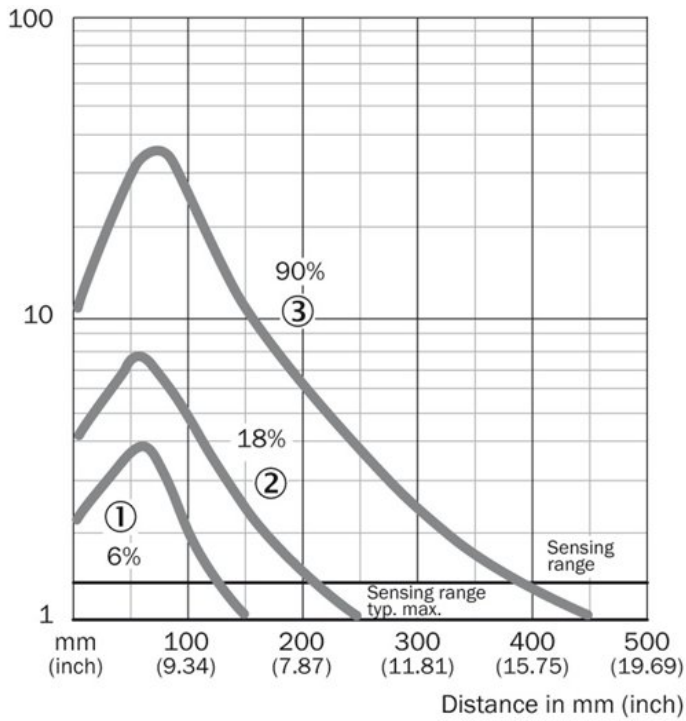

- |1| Sensing range on black, 6 % remission
- |2| Sensing range on grey, 18 % remission
- |3| Sensing range on white, 90 % remission

Connection type

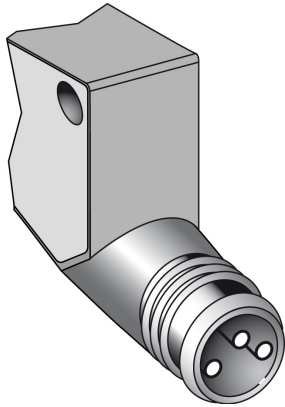

Light spot size

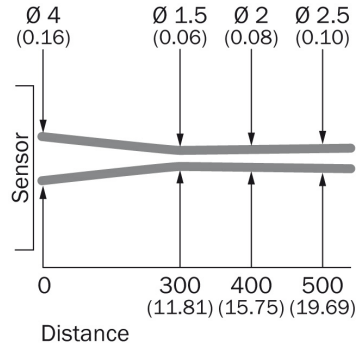

All dimensions in mm (inch)

Sensing range diagram

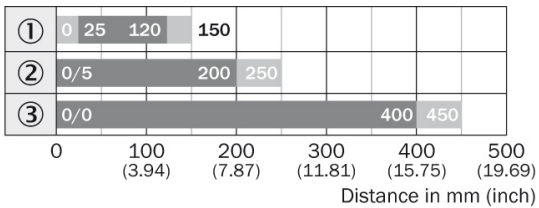

■ Sensing range ■ Sensing range typ. max.

- ① Sensing range on black, 6 % remission
- ② Sensing range on gray, 18 % remission
- ③ Sensing range on white, 90 % remission

Australia

Phone +61 3 9457 0600
1800 334 802 – tollfree
E-Mail sales@sick.com.au

Belgium/Luxembourg

Phone +32 (0)2 466 55 66
E-Mail info@sick.be

Brasil

Phone +55 11 3215-4900
E-Mail sac@sick.com.br

Canada

Phone +1 905 771 14 44
E-Mail information@sick.com

Ceská Republika

Phone +420 2 57 91 18 50
E-Mail sick@sick.cz

China

Phone +86 4000 121 000
E-Mail info.china@sick.net.cn
Phone +852-2153 6300
E-Mail ghk@sick.com.hk

Danmark

Phone +45 45 82 64 00
E-Mail sick@sick.dk

Deutschland

Phone +49 211 5301-301
E-Mail kundenservice@sick.de

España

Phone +34 93 480 31 00
E-Mail info@sick.es

France

Phone +33 1 64 62 35 00
E-Mail info@sick.fr

Great Britain

Phone +44 (0)1727 831121
E-Mail info@sick.co.uk

India

Phone +91-22-4033 8333
E-Mail info@sick-india.com

Israel

Phone +972-4-6801000
E-Mail info@sick-sensors.com

Italia

Phone +39 02 27 43 41
E-Mail info@sick.it

Japan

Phone +81 (0)3 3358 1341
E-Mail support@sick.jp

Magyarország

Phone +36 1 371 2680
E-Mail office@sick.hu

Nederlands

Phone +31 (0)30 229 25 44
E-Mail info@sick.nl

Norge

Phone +47 67 81 50 00
E-Mail austefjord@sick.no

Österreich

Phone +43 (0)22 36 62 28 8-0
E-Mail office@sick.at

Polska

Phone +48 22 837 40 50
E-Mail info@sick.pl

România

Phone +40 356 171 120
E-Mail office@sick.ro

Russia

Phone +7-495-775-05-30
E-Mail info@sick.ru

Schweiz

Phone +41 41 619 29 39
E-Mail contact@sick.ch

Singapore

Phone +65 6744 3732
E-Mail admin@sicksgp.com.sg

Slovenija

Phone +386 (0)1-47 69 990
E-Mail office@sick.si

South Africa

Phone +27 11 472 3733
E-Mail info@sickautomation.co.za

South Korea

Phone +82 2 786 6321/4
E-Mail info@sickkorea.net

Suomi

Phone +358-9-25 15 800
E-Mail sick@sick.fi

Sverige

Phone +46 10 110 10 00
E-Mail info@sick.se

Taiwan

Phone +886-2-2375-6288
E-Mail sales@sick.com.tw

Türkiye

Phone +90 (216) 528 50 00
E-Mail info@sick.com.tr

United Arab Emirates

Phone +971 (0) 4 8865 878
E-Mail info@sick.ae

USA/México

Phone +1(952) 941-6780
1 800-325-7425 – tollfree
E-Mail info@sickusa.com

More representatives and agencies
at www.sick.com