



Photoelectric sensors
V180-2, Photoelectric proximity sensor,
Background suppression

VTB180-2F32417



Model Name > [VTB180-2F32417](#)
Part No. > [6044020](#)



Illustration may differ

At a glance

- Detecting presence and positioning in:
 - - Storage/conveying technology
 - - Material handling technology
 - - Packaging industry
 - - Transportation industry
 - - Automotive industry
 - - Wood industry
- Applications with limited space behind the sensor (radial types)

Your benefits

- Lowest-cost M18 cylindrical sensor on the market reduces installation costs
- Bright red sender LED simplifies alignment and saves installation time
- Bright power and signal LEDs with 360° visibility offer quick and simple troubleshooting, reducing installation and maintenance costs
- The flat and smooth lens reduces the collection of dust and dirt, ensuring safe operation with less maintenance and fewer costs
- Sensors with background suppression for reliable detection of challenging objects



Features

Sensor/detection principle:	Photoelectric proximity sensor, Background suppression
Housing design (light emission):	Cylindrical, straight
Thread diameter (housing):	M18 x 1
Optical axis:	Axial
Sensing range max.:	10 mm ... 350 mm ¹⁾
Sensing range:	30 mm ... 200 mm ²⁾
Type of light:	Visible red light
Light source:	LED ³⁾
Wave length:	632 nm
Angle of dispersion:	Ca. 2.8 °
Adjustment:	Potentiometer, 4-turn
Light spot size (distance):	Ø 15 mm (300 mm)

^{1) 2)} Object with 90 % reflectance (referred to standard white DIN 5033) ³⁾ Average service life of 100,000 h at T_A = +25 °C

Mechanics/electronics

Supply voltage:	10 V DC ... 30 V DC ¹⁾
Ripple:	± 10 %
Power consumption:	≤ 35 mA ²⁾
Output type:	PNP
Switching mode:	Light switching
Signal voltage PNP HIGH/LOW:	Approx. V _S - 1.8 V / 0 V
Output current I _{max} :	≤ 100 mA
Response time:	≤ 1 ms ³⁾
Switching frequency:	≤ 500 Hz ⁴⁾
Connection type:	Connector M12, 4-pin
Circuit protection:::	A, B, D ^{5) 6) 7)}
Protection class:	III
Weight:	18 g
Housing material:	Plastic, PBT/PC
Optics material:	PMMA
Enclosure rating:	IP 67
Items supplied:	Fastening nuts (2 x)
Ambient operating temperature:	-25 °C ... 55 °C
Ambient storage temperature:	-40 °C ... 70 °C

¹⁾ Limit values, operation in short-circuit protected network max. 8 A ²⁾ Without load ³⁾ Signal transit time with resistive load ⁴⁾ With light/dark ratio 1:1 ⁵⁾ A = V_S
connections reverse-polarity protected ⁶⁾ B = inputs and output reverse-polarity protected ⁷⁾ D = outputs overcurrent and short-circuit protected

Dimensional drawing

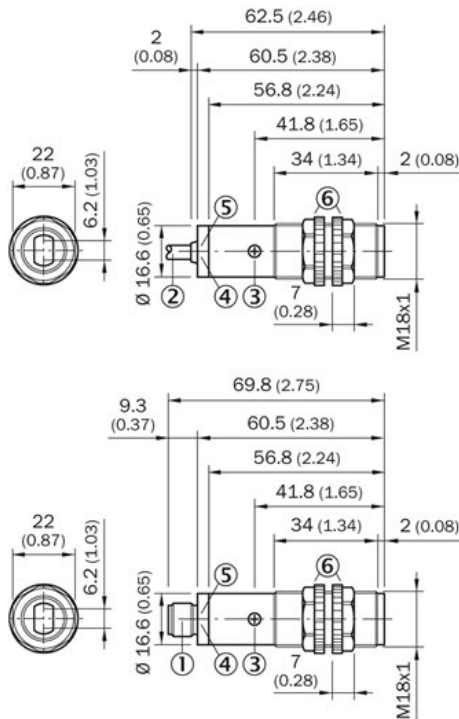

- [1] Connector M12, 4-pin
- [2] Connection cable 2 m
- [3] Sensitivity control (potentiometer, 270°)
- [4] LED indicator orange: switching output active
- [5] LED indicator green: strength indicator
- [6] fastening nuts (2 x); width across 22, PC

Adjustments possible

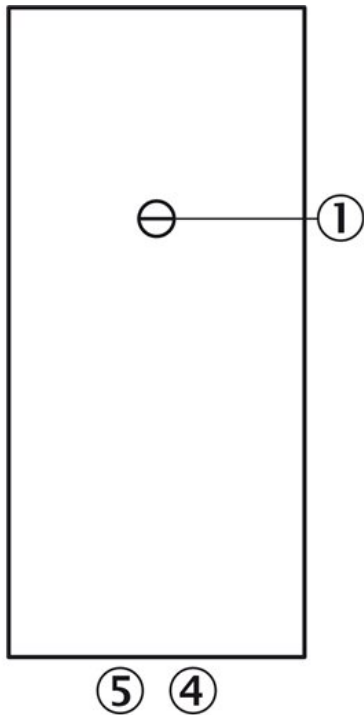

- |3| Sensitivity adjustment 270°
- |4| LED indicator orange: switching output active
- |5| LED indicator green

Connection diagram

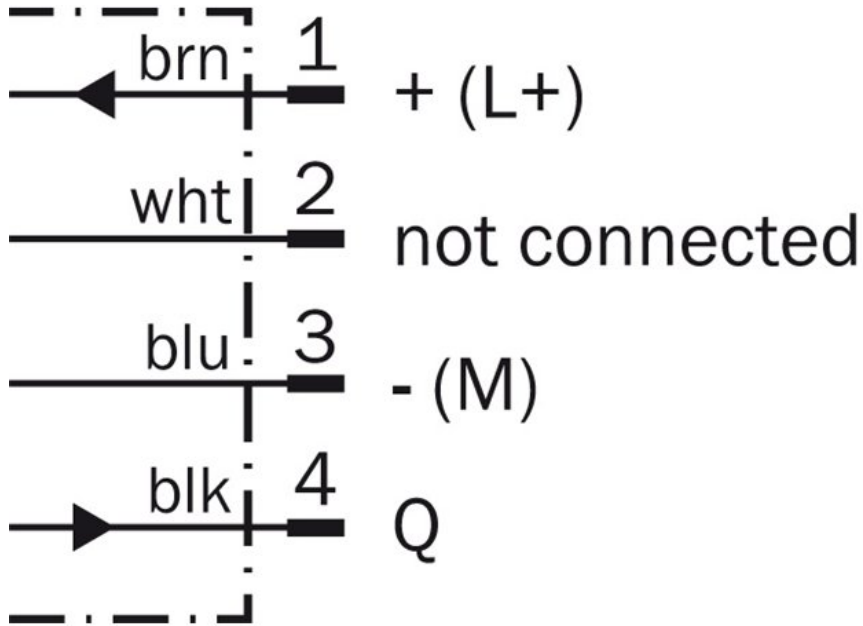

Characteristic curve

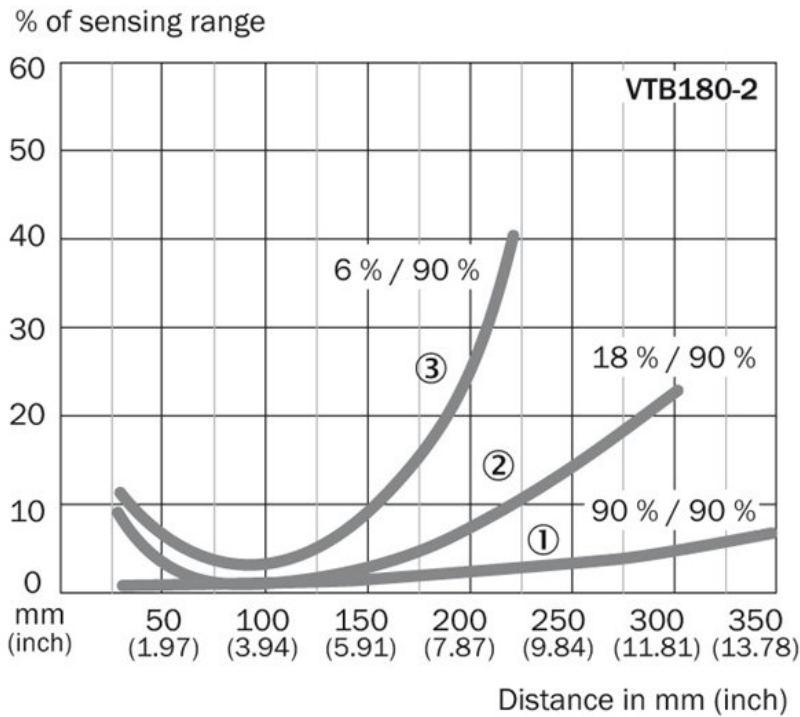

Connection type

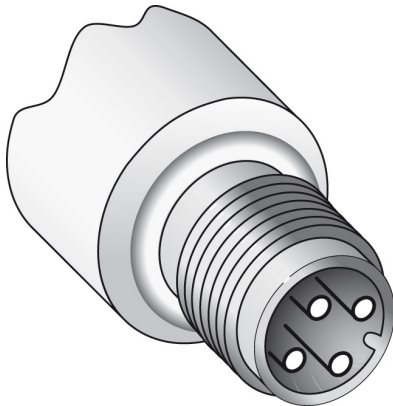

Light spot size

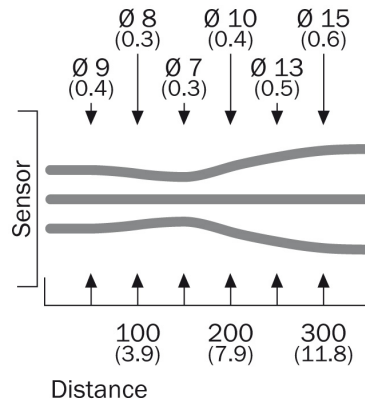

Sensing range diagram

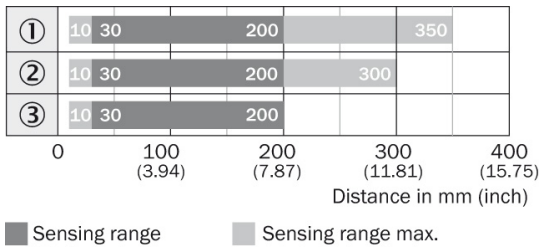

Australia

Phone +61 3 9457 0600
1800 334 802 – tollfree
E-Mail sales@sick.com.au

Belgium/Luxembourg

Phone +32 (0)2 466 55 66
E-Mail info@sick.be

Brasil

Phone +55 11 3215-4900
E-Mail sac@sick.com.br

Canada

Phone +1 905 771 14 44
E-Mail information@sick.com

Ceská Republika

Phone +420 2 57 91 18 50
E-Mail sick@sick.cz

China

Phone +86 4000 121 000
E-Mail info.china@sick.net.cn
Phone +852-2153 6300
E-Mail ghk@sick.com.hk

Danmark

Phone +45 45 82 64 00
E-Mail sick@sick.dk

Deutschland

Phone +49 211 5301-301
E-Mail kundenservice@sick.de

España

Phone +34 93 480 31 00
E-Mail info@sick.es

France

Phone +33 1 64 62 35 00
E-Mail info@sick.fr

Great Britain

Phone +44 (0)1727 831121
E-Mail info@sick.co.uk

India

Phone +91-22-4033 8333
E-Mail info@sick-india.com

Israel

Phone +972-4-6801000
E-Mail info@sick-sensors.com

Italia

Phone +39 02 27 43 41
E-Mail info@sick.it

Japan

Phone +81 (0)3 3358 1341
E-Mail support@sick.jp

Magyarország

Phone +36 1 371 2680
E-Mail office@sick.hu

Nederlands

Phone +31 (0)30 229 25 44
E-Mail info@sick.nl

Norge

Phone +47 67 81 50 00
E-Mail austefjord@sick.no

Österreich

Phone +43 (0)22 36 62 28 8-0
E-Mail office@sick.at

Polska

Phone +48 22 837 40 50
E-Mail info@sick.pl

România

Phone +40 356 171 120
E-Mail office@sick.ro

Russia

Phone +7-495-775-05-30
E-Mail info@sick.ru

Schweiz

Phone +41 41 619 29 39
E-Mail contact@sick.ch

Singapore

Phone +65 6744 3732
E-Mail admin@sicksgp.com.sg

Slovenija

Phone +386 (0)1-47 69 990
E-Mail office@sick.si

South Africa

Phone +27 11 472 3733
E-Mail info@sickautomation.co.za

South Korea

Phone +82 2 786 6321/4
E-Mail info@sickkorea.net

Suomi

Phone +358-9-25 15 800
E-Mail sick@sick.fi

Sverige

Phone +46 10 110 10 00
E-Mail info@sick.se

Taiwan

Phone +886-2-2375-6288
E-Mail sales@sick.com.tw

Türkiye

Phone +90 (216) 528 50 00
E-Mail info@sick.com.tr

United Arab Emirates

Phone +971 (0) 4 8865 878
E-Mail info@sick.ae

USA/México

Phone +1(952) 941-6780
1 800-325-7425 – tollfree
E-Mail info@sickusa.com

More representatives and agencies
at www.sick.com