



Luminescence sensors LUT3, LUT3-9

LUT3-910



Model Name > LUT3-910
Part No. > 1019285



Features

Dimensions (L x W x H):	80 mm x 30.4 mm x 53 mm
Sensing distance ¹⁾ :	10 mm
Light source ^{2), 3)} :	UV-LED
Light spot size:	2 mm x 6 mm
Receiving filters:	KV 418 (standard)
Receiving range:	450 nm ... 750 nm
Adjustment:	Manual (potentiometer)
Output function:	Light switching

¹⁾ From front edge of lens ²⁾ Average service life of 100,000 h at T_A = +25 °C ³⁾ Wave length: 375 nm

Mechanics/electronics

Supply voltage V _s ¹⁾ :	DC 12 V ... 30 V
Ripple ²⁾ :	< 2 V _{pp}
Power consumption ³⁾ :	< 60 mA
Switching frequency ⁴⁾ :	1.5 kHz
Response time ⁵⁾ :	350 µs
Output type:	PNP: HIGH = V _S - ≤ 3 V / LOW = approx. 0 V NPN: HIGH = approx. V _S / LOW ≤ 2 V
Switching mode:	PNP/NPN
Output current I _{max.} :	100 mA
Connection type:	Connector M12, 5-pin
Protection class ⁶⁾ :	II
Circuit protection:	Output Q short-circuit protected Interference suppression VS connections reverse-polarity protected
Enclosure rating:	IP 67
Weight:	Ca. 400 g
Housing material:	Zinc diecast

¹⁾ Limit values: operation in short-circuit protected network max. 8 A ²⁾ May not exceed or fall short of V_S tolerances ³⁾ Without load ⁴⁾ With light/dark ratio 1:1 ⁵⁾

Signal transit time with resistive load ⁶⁾ Reference voltage DC 50 V

Ambient data

Ambient temperature:

Operation: -10 ... 55 °C

Storage: -25 ... 75 °C

Shock load:

According to IEC 60068

Dimensional drawing

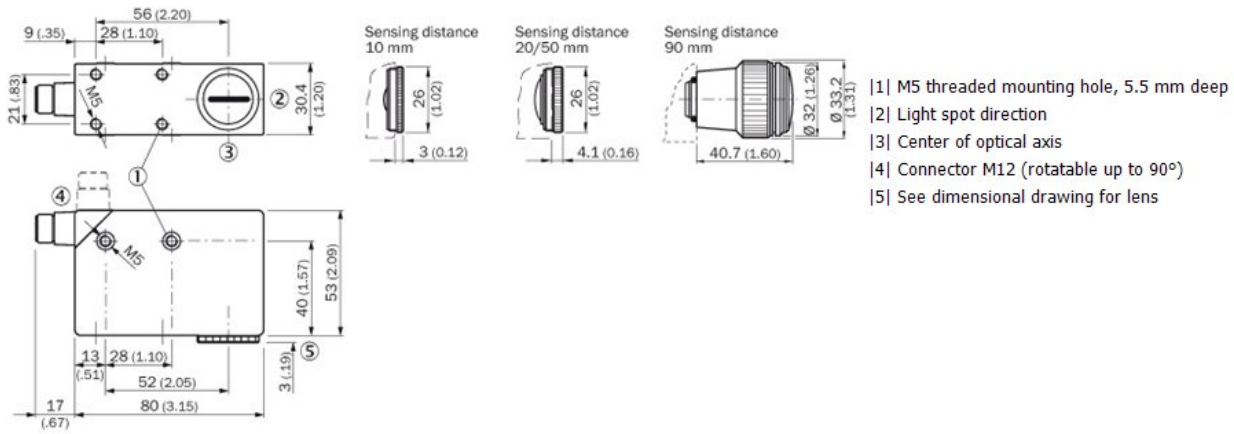

All dimensions in mm (inch)

Adjustments

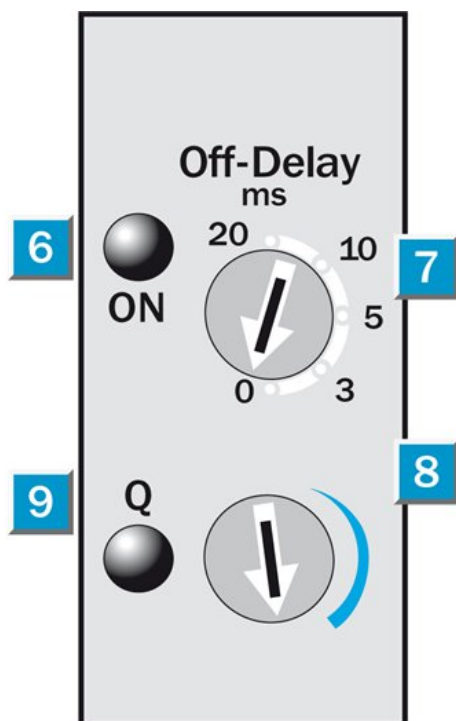

- |6| Operating indicator
- |7| time delay selector switch
- |8| Sensitivity adjustment
- |9| Output indicator

Connection type

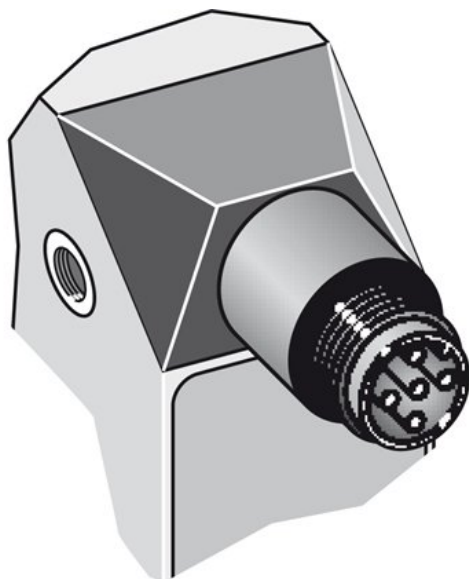

Connection diagram

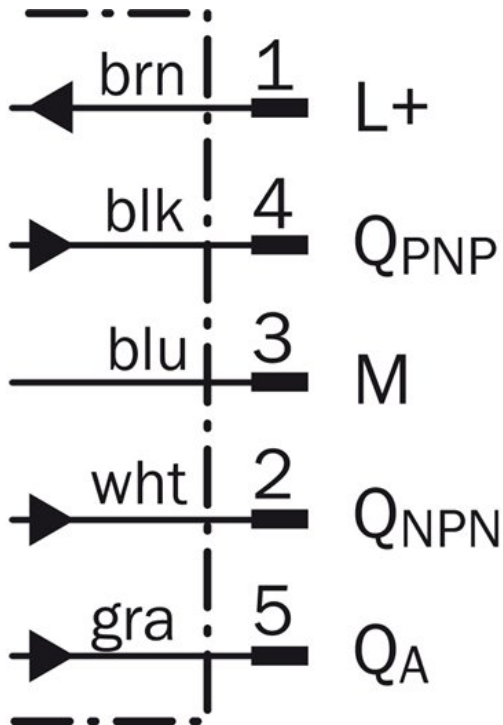

Characteristic curve

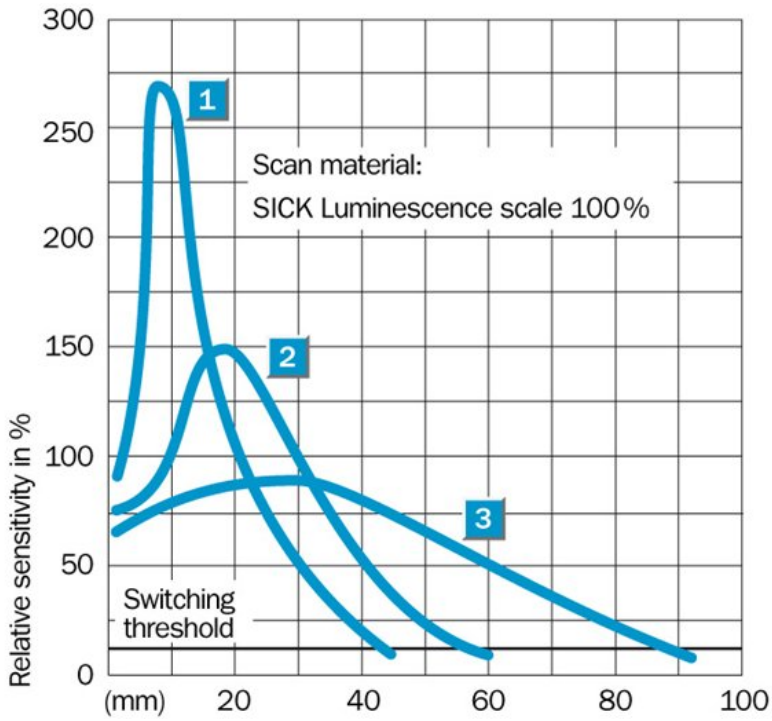

Australia

Phone +61 3 9457 0600
1800 334 802 – tollfree
E-Mail sales@sick.com.au

Belgium/Luxembourg

Phone +32 (0)2 466 55 66
E-Mail info@sick.be

Brasil

Phone +55 11 3215-4900
E-Mail sac@sick.com.br

Canada

Phone +1 905 771 14 44
E-Mail information@sick.com

Ceská Republika

Phone +420 2 57 91 18 50
E-Mail sick@sick.cz

China

Phone +86 4000 121 000
E-Mail info.china@sick.net.cn
Phone +852-2153 6300
E-Mail ghk@sick.com.hk

Danmark

Phone +45 45 82 64 00
E-Mail sick@sick.dk

Deutschland

Phone +49 211 5301-301
E-Mail kundenservice@sick.de

España

Phone +34 93 480 31 00
E-Mail info@sick.es

France

Phone +33 1 64 62 35 00
E-Mail info@sick.fr

Great Britain

Phone +44 (0)1727 831121
E-Mail info@sick.co.uk

India

Phone +91-22-4033 8333
E-Mail info@sick-india.com

Israel

Phone +972-4-6801000
E-Mail info@sick-sensors.com

Italia

Phone +39 02 27 43 41
E-Mail info@sick.it

Japan

Phone +81 (0)3 3358 1341
E-Mail support@sick.jp

Magyarország

Phone +36 1 371 2680
E-Mail office@sick.hu

Nederlands

Phone +31 (0)30 229 25 44
E-Mail info@sick.nl

Norge

Phone +47 67 81 50 00
E-Mail austefjord@sick.no

Österreich

Phone +43 (0)22 36 62 28 8-0
E-Mail office@sick.at

Polska

Phone +48 22 837 40 50
E-Mail info@sick.pl

România

Phone +40 356 171 120
E-Mail office@sick.ro

Russia

Phone +7-495-775-05-30
E-Mail info@sick.ru

Schweiz

Phone +41 41 619 29 39
E-Mail contact@sick.ch

Singapore

Phone +65 6744 3732
E-Mail admin@sicksgp.com.sg

Slovenija

Phone +386 (0)1-47 69 990
E-Mail office@sick.si

South Africa

Phone +27 11 472 3733
E-Mail info@sickautomation.co.za

South Korea

Phone +82 2 786 6321/4
E-Mail info@sickkorea.net

Suomi

Phone +358-9-25 15 800
E-Mail sick@sick.fi

Sverige

Phone +46 10 110 10 00
E-Mail info@sick.se

Taiwan

Phone +886-2-2375-6288
E-Mail sales@sick.com.tw

Türkiye

Phone +90 (216) 528 50 00
E-Mail info@sick.com.tr

United Arab Emirates

Phone +971 (0) 4 8865 878
E-Mail info@sick.ae

USA/México

Phone +1(952) 941-6780
1 800-325-7425 – tollfree
E-Mail info@sickusa.com

More representatives and agencies
at www.sick.com