



Image-based code readers  
LECTOR®62x / LECTOR®620 Professional

ICR620S-T11504 Professional



**Model Name** > ICR620S-T11504 Professional  
**Part No.** > 1054375



**At a glance**

- Decoding of most popular code types: 1D, 2D, direct part marking
- Easy integration with industrial networks: Serial, USB, Ethernet TCP/IP, EtherNet/IP, PROFIBUS, CAN
- Auto setup with function buttons, aiming laser, automatic focus teach-in and green feedback LED - for quick setup without a PC
- Compact design and industrial housing with swivel connector
- Analysis tools include live image capturing, code verification and read rate view

**Your benefits**

- Intelligent decoding algorithms provide reliable reading performance for improved read rates and throughput
- IDpro facilitates integration with most popular industrial networks
- Intuitive setup with function buttons, auto setup, aiming laser, automatic focus teach-in and green feedback LED reduces training and installation time and costs
- Compact design and swivel connector make it easy to install in reduced spaces
- Quick analysis of read rate performance and code quality allows for efficient control
- Cloning back-up systems ensure low machine downtime in the event of unexpected incidents
- SICK LifeTime Services give you peace of mind

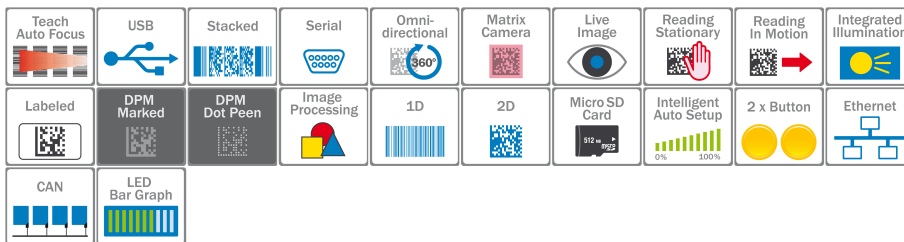

**Features**

Reading field:	Side
Focus:	Auto focus (during teach-in)
Sensor:	CMOS matrix sensor, gray scale values
Sensor resolution:	752 px x 480 px (WVGA)
Focal length:	7 mm
Code resolution:	≥0.1 mm <sup>1)</sup>
Reading distance (at code resolution):	40 mm ... 1,500 mm (2.6 mm) <sup>2)</sup>
Scanning frequency:	60 Hz, WVGA resolution
Internal lighting:	Blue, Red

Light source:	Lighting LEDs: visible red light ( $\lambda = 617 \pm 15 \text{ nm}$ ), visible blue light ( $\lambda = 470 \pm 15 \text{ nm}$ ) feedback spot: visible green light ( $\lambda = 525 \pm 15 \text{ nm}$ ) Aiming laser: visible red light ( $\lambda = 630 \text{ nm} \dots 680 \text{ nm}$ )
Laser class:	1 (IEC 60825-1 (2007-3)), complies with 21 CFR 1040.10 except for the tolerance according to "Laser Notice No. 50" from June 24, 2007
LED class:	1 (IEC 62471 (2006-07) / EN 62471 (2008-09)), radiance $L_{\text{B}} < 10 \text{ kW}/(\text{m}^2\text{sr})$ within 100 s, $L_{\text{R}} < 28/\alpha \text{ kW}/(\text{m}^2\text{sr})$ within 10 s at distance $> 200 \text{ mm}$
MTBF:	75,000 h

1) 2) Valid for Data Matrix, PDF417 and 1D codes with good printing quality

## Performance

Bar code types:	Interleaved 2 of 5, Codabar, Code 128, Code 32, Code 39, Code 93, GS1 DataBar, GS1-128/EAN 128, Pharmacode, UPC/GTIN/EAN
2D code types:	Data Matrix ECC200, GS1 Data-Matrix, PDF417, PDF417 Truncated, QR code
No. of codes per reading interval:	1 ... 50
No. of characters per reading interval:	500 (for multiplexer function in CAN operation)
Transport speed:	$\leq 4 \text{ m/s}$
Internal image storage:	135 MB
Code qualification:	On the basis of ISO/IEC 16022, ISO/IEC 15415, ISO/IEC 15416, ISO/IEC 18004

## Interfaces

Serial (RS-232, RS-422):	✓
Function (Serial (RS-232, RS-422)):	-
Data transmission rate (Serial (RS-232, RS-422)):	300 Baud ... 115.2 kBaud, AUX: 57.6 kBaud (RS-232)
USB:	✓
Remark (USB):	USB 2.0
Ethernet:	✓
Function (Ethernet):	Host, AUX, image transmission
Data transmission rate (Ethernet):	10/100 Mbit
Protocol (Ethernet):	TCP/IP, FTP (image transmission), PROFINET, EtherNet/IP, EtherCAT (optional via external connection module CDF600-2)
CAN bus:	✓
Function (CAN bus):	SICK CAN sensor network (Master/Slave, Multiplexer/Server)
Data transmission rate (CAN bus):	20 kbit/s ... 1 Mbit/s
Protocol (CAN bus):	CANopen, CSN (SICK CAN Sensor Network)
PROFIBUS DP:	✓
Remark (PROFIBUS DP):	Optional via external connection module (CDF600-2)
DeviceNet:	-
Acoustic indicators:	Beeper/buzzer (can be switched off, can be assigned a function to signal a result)
Control elements:	2 buttons (choose and start/stop functions)
Optical indicators:	16 LEDs (5 x status display, 10 x LED bar graph, 1 green feedback spot)
Switching inputs:	4 ("Sensor 1", "Sensor 2", 2 inputs via optional CMC600 in CDB620/CDM420)
Switching outputs:	4 ("Result 1", "Result 2", 2 outputs via CMC in CDB620/CDM420 or "Result 1", "Result 2", "Result 3", "Result 4" using the 17-pin cable with open end)
Reading pulse:	Auto pulse, CAN, Ethernet, Non-powered, Presentation mode, Switching inputs, Serial interface
Memory card:	MicroSD memory card (flash card) max. 32 GB, optional

## Mechanics/electronics

---

Operating voltage:	10 V DC ... 30 V DC
Power consumption:	Typ. 3 W
Electrical connection:	1 x M12, 17-pin plug 1 x M12, 4-pin socket Ethernet Cylindrical connectors
Housing:	Die-cast aluminum
Housing color:	Light blue (RAL 5012)
Weight:	170 g
Dimensions:	71 mm x 43 mm x 35.6 mm <sup>1)</sup>
Enclosure rating:	IP 67 (EN 60529 (1991-10), EN 60529/A2 (2002-02))
Protection class:	III
Lens:	Integrated

<sup>1)</sup> Swivel connector is 17.8 mm longer

## Ambient data

---

Electromagnetic compatibility (EMC):	EN 61000-6-2 (2006-03)/EN 61000-6-2 (2009-05)
Vibration resistance:	EN 60068-2-6 (2008-02)
Shock resistance:	EN 60068-2-27 (2009-05)
Electrical safety:	EN 60950-1 (2006-04)/EN 60950-1/A11 (2009-03)
Ambient operating temperature:	0 °C ... 50 °C
Storage temperature:	-20 °C ... 70 °C
Permissible relative humidity:	90 %, non-condensing
Ambient light safety:	2,000 lx, on code

## Dimensional drawing

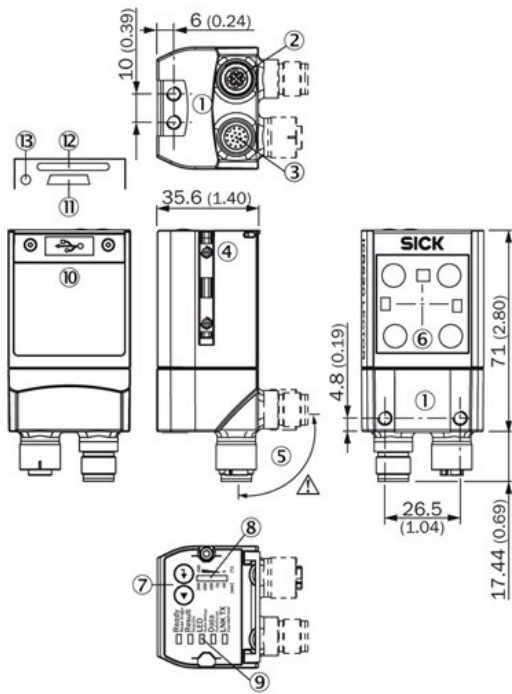

- [1] blind hole thread M5, 5 mm deep (4 x), for mounting
- [2] Ethernet connection
- [3] "Power/Serial Data/CAN/I/O" connection
- [4] Sliding nut M5, 5 mm deep (2 x), for mounting (as alternative)
- [5] Swivel connector unit
- [6] Reading field
- [7] Function button (2 x)
- [8] Bar graph display
- [9] LED for status display (2 levels), 5 x
- [10] Cover (flap)
- [11] "Micro USB" connection
- [12] Slot for microSD memory card
- [13] LED for microSD memory card

## Field of view 1

Field of view/length in mm (inch)

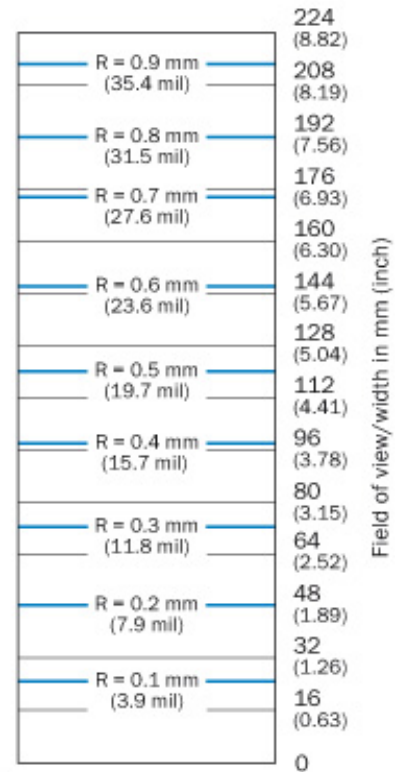
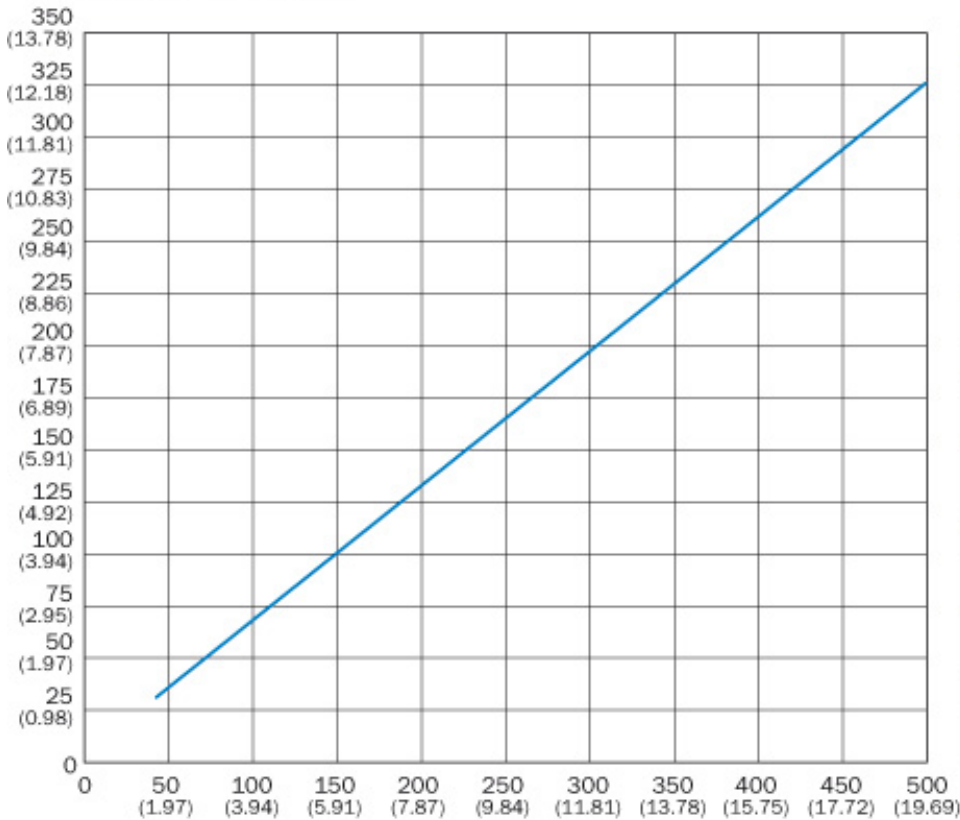

Reading distance/focus position in mm (inch)

R = resolution

## Field of view 2

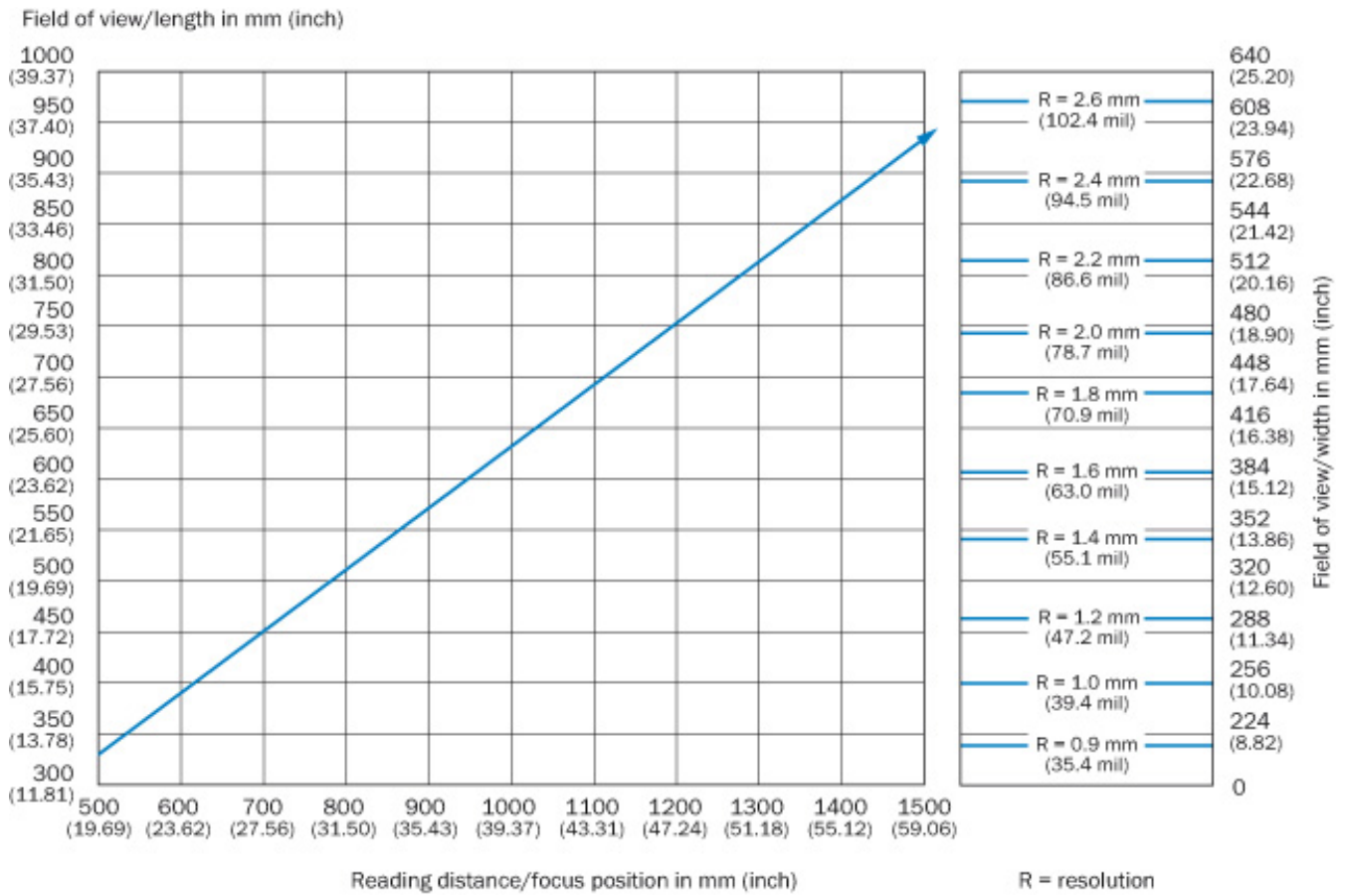

### Depth of field diagram 1

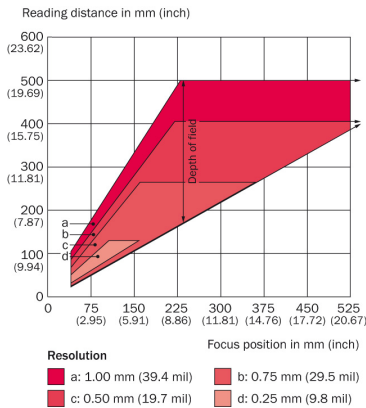

### Depth of field diagram 2

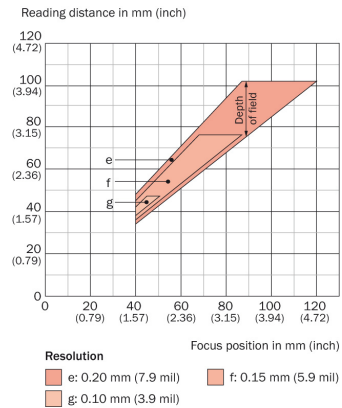

**Australia**

Phone +61 3 9457 0600  
1800 334 802 – tollfree  
E-Mail sales@sick.com.au

**Belgium/Luxembourg**

Phone +32 (0)2 466 55 66  
E-Mail info@sick.be

**Brasil**

Phone +55 11 3215-4900  
E-Mail sac@sick.com.br

**Canada**

Phone +1 905 771 14 44  
E-Mail information@sick.com

**Ceská Republika**

Phone +420 2 57 91 18 50  
E-Mail sick@sick.cz

**China**

Phone +86 4000 121 000  
E-Mail info.china@sick.net.cn  
Phone +852-2153 6300  
E-Mail ghk@sick.com.hk

**Danmark**

Phone +45 45 82 64 00  
E-Mail sick@sick.dk

**Deutschland**

Phone +49 211 5301-301  
E-Mail kundenservice@sick.de

**España**

Phone +34 93 480 31 00  
E-Mail info@sick.es

**France**

Phone +33 1 64 62 35 00  
E-Mail info@sick.fr

**Great Britain**

Phone +44 (0)1727 831121  
E-Mail info@sick.co.uk

**India**

Phone +91-22-4033 8333  
E-Mail info@sick-india.com

**Israel**

Phone +972-4-6801000  
E-Mail info@sick-sensors.com

**Italia**

Phone +39 02 27 43 41  
E-Mail info@sick.it

**Japan**

Phone +81 (0)3 3358 1341  
E-Mail support@sick.jp

**Magyarország**

Phone +36 1 371 2680  
E-Mail office@sick.hu

**Nederlands**

Phone +31 (0)30 229 25 44  
E-Mail info@sick.nl

**Norge**

Phone +47 67 81 50 00  
E-Mail austefjord@sick.no

**Österreich**

Phone +43 (0)22 36 62 28 8-0  
E-Mail office@sick.at

**Polska**

Phone +48 22 837 40 50  
E-Mail info@sick.pl

**România**

Phone +40 356 171 120  
E-Mail office@sick.ro

**Russia**

Phone +7-495-775-05-30  
E-Mail info@sick.ru

**Schweiz**

Phone +41 41 619 29 39  
E-Mail contact@sick.ch

**Singapore**

Phone +65 6744 3732  
E-Mail admin@sicksgp.com.sg

**Slovenija**

Phone +386 (0)1-47 69 990  
E-Mail office@sick.si

**South Africa**

Phone +27 11 472 3733  
E-Mail info@sickautomation.co.za

**South Korea**

Phone +82 2 786 6321/4  
E-Mail info@sickkorea.net

**Suomi**

Phone +358-9-25 15 800  
E-Mail sick@sick.fi

**Sverige**

Phone +46 10 110 10 00  
E-Mail info@sick.se

**Taiwan**

Phone +886-2-2375-6288  
E-Mail sales@sick.com.tw

**Türkiye**

Phone +90 (216) 528 50 00  
E-Mail info@sick.com.tr

**United Arab Emirates**

Phone +971 (0) 4 8865 878  
E-Mail info@sick.ae

**USA/México**

Phone +1(952) 941-6780  
1 800-325-7425 – tollfree  
E-Mail info@sickusa.com

More representatives and agencies  
at [www.sick.com](http://www.sick.com)