



Level sensors  
TDR level sensor, LFT

LFT0600-01A1A50



**Model Name** > [LFT0600-01A1A50](#)  
**Part No.** > [1045912](#)



*Product may differ  
from illustration*

#### At a glance

- Time-of-flight measurement technology
- Up to 4 switching outputs, combination of analog and digital outputs possible
- Small deadband, ideal for small containers
- Simple, single-button teach
- Flexible probe length up to 2,000 mm
- No re-calibration necessary when fluid properties change
- Measurement independent of installation conditions and tank material
- Filter available for dirty and contaminated fluids

#### Your benefits

- High resolution, accuracy, and repeatability
- Reliable measurement independent of liquid type, installation condition and tank material due to TDR technology
- One device performs the functionality for switching and continuous applications, reducing the number of sensors required
- Reduced installation time and costs through high flexibility
- No re-calibration necessary, saving commissioning time
- A variety of available probe lengths meets the needs of many applications
- No moving parts reduces maintenance costs



#### Features

Medium:	Fluids
Measurement:	Switch, Continuous
Probe length:	600 mm
Measuring range:	30 mm ... 590 mm
Process pressure:	≤ 1 bar
Process temperature:	0 °C ... 80 °C
WHG approval:	-
GOST approval:	✓
UL approval:	-

#### Performance

Resolution:	≤ 1 mm
Accuracy of sensor element:	± 3 mm
Repeatability:	2
Dielectricity constant:	1.8

Response time: 200 ms

---

**Mechanical data**

Inactive area: Each 10 mm  
Housing material: PBT  
Process connection: G 3/4 A  
Wetted parts: Stainless steel 316L/301, PBT, PTFE

---

**Electrical data**

Temperature drift:  $\pm 0.05$  mm/K  
Enclosure rating: IP 67  
Supply voltage: 18 V DC ... 30 V DC  
Ripple:  $\leq 5$  Vpp  
Power consumption:  $\leq 90$  mA at 24 V without output load  
Protection class: III  
Initialization time:  $\leq 4$  s  
Output signal: 4 mA ... 20 mA, 1x PNP, normally closed, hysteresis adjustable  
Output load:  $< 500 \Omega$   
Upper signal level: 20 ... 20.5  
Lower signal level: 3.8 ... 4  
Hysteresis: 3 mm  
Signal voltage HIGH:  $V_s - 2$  V  
Signal voltage LOW:  $0 \text{ V} \leq 1 \text{ V}$   
Capacitive load:  $< 100$  nF  
Inductive load:  $\leq 1$  H  
Connection type: M12x1, 5-pin

---

**Ambient data**

Ambient operating temperature:  $-10 \text{ }^\circ\text{C} \dots 60 \text{ }^\circ\text{C}$   
Ambient storage temperature:  $-40 \text{ }^\circ\text{C} \dots 80 \text{ }^\circ\text{C}$

**Dimensional drawing**

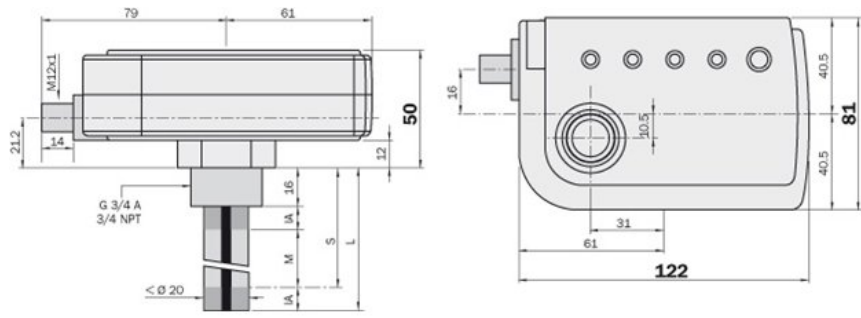

**Australia**

Phone +61 3 9457 0600  
1800 334 802 – tollfree  
E-Mail sales@sick.com.au

**Belgium/Luxembourg**

Phone +32 (0)2 466 55 66  
E-Mail info@sick.be

**Brasil**

Phone +55 11 3215-4900  
E-Mail sac@sick.com.br

**Canada**

Phone +1 905 771 14 44  
E-Mail information@sick.com

**Ceská Republika**

Phone +420 2 57 91 18 50  
E-Mail sick@sick.cz

**China**

Phone +86 4000 121 000  
E-Mail info.china@sick.net.cn  
Phone +852-2153 6300  
E-Mail ghk@sick.com.hk

**Danmark**

Phone +45 45 82 64 00  
E-Mail sick@sick.dk

**Deutschland**

Phone +49 211 5301-301  
E-Mail kundenservice@sick.de

**España**

Phone +34 93 480 31 00  
E-Mail info@sick.es

**France**

Phone +33 1 64 62 35 00  
E-Mail info@sick.fr

**Great Britain**

Phone +44 (0)1727 831121  
E-Mail info@sick.co.uk

**India**

Phone +91-22-4033 8333  
E-Mail info@sick-india.com

**Israel**

Phone +972-4-6801000  
E-Mail info@sick-sensors.com

**Italia**

Phone +39 02 27 43 41  
E-Mail info@sick.it

**Japan**

Phone +81 (0)3 3358 1341  
E-Mail support@sick.jp

**Magyarország**

Phone +36 1 371 2680  
E-Mail office@sick.hu

**Nederlands**

Phone +31 (0)30 229 25 44  
E-Mail info@sick.nl

**Norge**

Phone +47 67 81 50 00  
E-Mail austefjord@sick.no

**Österreich**

Phone +43 (0)22 36 62 28 8-0  
E-Mail office@sick.at

**Polska**

Phone +48 22 837 40 50  
E-Mail info@sick.pl

**România**

Phone +40 356 171 120  
E-Mail office@sick.ro

**Russia**

Phone +7-495-775-05-30  
E-Mail info@sick.ru

**Schweiz**

Phone +41 41 619 29 39  
E-Mail contact@sick.ch

**Singapore**

Phone +65 6744 3732  
E-Mail admin@sicksgp.com.sg

**Slovenija**

Phone +386 (0)1-47 69 990  
E-Mail office@sick.si

**South Africa**

Phone +27 11 472 3733  
E-Mail info@sickautomation.co.za

**South Korea**

Phone +82 2 786 6321/4  
E-Mail info@sickkorea.net

**Suomi**

Phone +358-9-25 15 800  
E-Mail sick@sick.fi

**Sverige**

Phone +46 10 110 10 00  
E-Mail info@sick.se

**Taiwan**

Phone +886-2-2375-6288  
E-Mail sales@sick.com.tw

**Türkiye**

Phone +90 (216) 528 50 00  
E-Mail info@sick.com.tr

**United Arab Emirates**

Phone +971 (0) 4 8865 878  
E-Mail info@sick.ae

**USA/México**

Phone +1(952) 941-6780  
1 800-325-7425 – tollfree  
E-Mail info@sickusa.com

More representatives and agencies  
at [www.sick.com](http://www.sick.com)