



Level sensors
TDR-sensor, LFT

LFT1600-01B0A40



Model Name > [LFT1600-01B0A40](#)

Part No. > [1043626](#)



Product may differ from illustration

At a glance

- Time-of-flight measurement technology
- Up to 4 switching outputs, combination of analog and digital outputs possible
- Small deadband, ideal for small containers
- Simple, single-button teach
- Flexible probe length up to 2,000 mm
- No re-calibration necessary when fluid properties change
- Measurement independent of installation conditions and tank material
- Filter available for dirty and contaminated fluids

Your benefits

- High resolution, accuracy, and repeatability
- Reliable measurement independent of liquid type, installation condition and tank material due to TDR technology
- One device performs the functionality for switching and continuous applications, reducing the number of sensors required
- Reduced installation time and costs through high flexibility
- No re-calibration necessary, saving commissioning time
- A variety of available probe lengths meets the needs of many applications
- No moving parts reduces maintenance costs



Features

Medium:	Fluids
Measurement:	Switch, Continuous
Probe length:	1,600 mm
Measuring range:	30 mm ... 1,590 mm
Process pressure:	1 bar
Process temperature:	0 °C ... 80 °C
WHG approval:	-
GOST approval:	✓
UL approval:	-

Performance

Resolution:	1 mm
Accuracy:	± 3 mm
Repeatability:	< 2 mm
Dielectricity constant:	≥ 1,8

Response time: 200 ms

Mechanical data

Inactive area: Each 10 mm
Housing material: PBT
Process connection: G 3/4 A
Wetted parts: Stainless steel 1.4404/316L

Electrical data

Enclosure rating: IP 67
Supply voltage: 18 V DC ... 30 V DC
Ripple: ≤ 5 Vpp
Power consumption: ≤ 90 mA at 24 V without output load
VDE protection class: III
Initialization time: 4 s
Output signal: 4, PNP, NCC
Hysteresis: 3 mm
Capacitive load: 100 nF
Inductive load: 1 H
Connection type: M12x1, 8-pol

Ambient data

Ambient operating temperature: -10 °C ... 60 °C
Ambient storage temperature: -40 °C ... 80 °C

Dimensional drawing

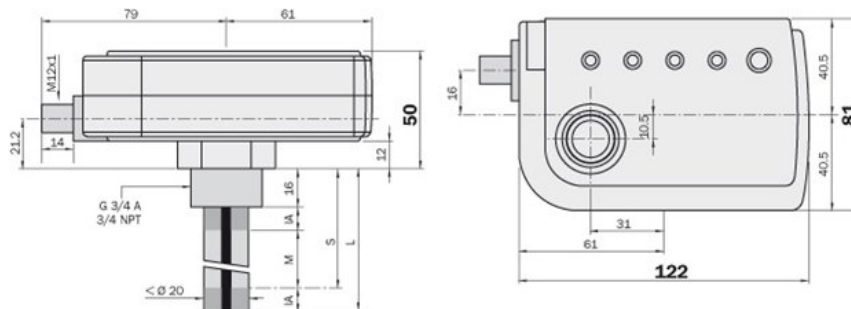

Australia

Phone +61 3 9457 0600
1800 334 802 – tollfree
E-Mail sales@sick.com.au

Belgium/Luxembourg

Phone +32 (0)2 466 55 66
E-Mail info@sick.be

Brasil

Phone +55 11 3215-4900
E-Mail sac@sick.com.br

Canada

Phone +1 905 771 14 44
E-Mail information@sick.com

Ceská Republika

Phone +420 2 57 91 18 50
E-Mail sick@sick.cz

China

Phone +86 4000 121 000
E-Mail info.china@sick.net.cn
Phone +852-2153 6300
E-Mail ghk@sick.com.hk

Danmark

Phone +45 45 82 64 00
E-Mail sick@sick.dk

Deutschland

Phone +49 211 5301-301
E-Mail kundenservice@sick.de

España

Phone +34 93 480 31 00
E-Mail info@sick.es

France

Phone +33 1 64 62 35 00
E-Mail info@sick.fr

Great Britain

Phone +44 (0)1727 831121
E-Mail info@sick.co.uk

India

Phone +91-22-4033 8333
E-Mail info@sick-india.com

Israel

Phone +972-4-6801000
E-Mail info@sick-sensors.com

Italia

Phone +39 02 27 43 41
E-Mail info@sick.it

Japan

Phone +81 (0)3 3358 1341
E-Mail support@sick.jp

Magyarország

Phone +36 1 371 2680
E-Mail office@sick.hu

Nederlands

Phone +31 (0)30 229 25 44
E-Mail info@sick.nl

Norge

Phone +47 67 81 50 00
E-Mail austefjord@sick.no

Österreich

Phone +43 (0)22 36 62 28 8-0
E-Mail office@sick.at

Polska

Phone +48 22 837 40 50
E-Mail info@sick.pl

România

Phone +40 356 171 120
E-Mail office@sick.ro

Russia

Phone +7-495-775-05-30
E-Mail info@sick.ru

Schweiz

Phone +41 41 619 29 39
E-Mail contact@sick.ch

Singapore

Phone +65 6744 3732
E-Mail admin@sicksgp.com.sg

Slovenija

Phone +386 (0)1-47 69 990
E-Mail office@sick.si

South Africa

Phone +27 11 472 3733
E-Mail info@sickautomation.co.za

South Korea

Phone +82 2 786 6321/4
E-Mail info@sickkorea.net

Suomi

Phone +358-9-25 15 800
E-Mail sick@sick.fi

Sverige

Phone +46 10 110 10 00
E-Mail info@sick.se

Taiwan

Phone +886-2-2375-6288
E-Mail sales@sick.com.tw

Türkiye

Phone +90 (216) 528 50 00
E-Mail info@sick.com.tr

United Arab Emirates

Phone +971 (0) 4 8865 878
E-Mail info@sick.ae

USA/México

Phone +1(952) 941-6780
1 800-325-7425 – tollfree
E-Mail info@sickusa.com

More representatives and agencies
at www.sick.com