



Level sensors
Vibrating level switch, LBV320

LBV320-XXHGD-RANX02400



Model Name > **LBV320-XXHGDRANX02400**
Part No. > **6038468**



Product may differ from illustration

At a glance

- Rugged device design with suspension cable up to 80 m
- Several housing materials and electrical outputs available
- Immune to deposit formation
- Commissioning without filling
- Process temperature up to 150 °C
- Very high repeatability
- ATEX versions (1D/2D/1G/2G) available
- Short versions (LBV310) and tube-extended devices (LBV330) available

Your benefits

- Easy installation and commissioning, no calibration necessary
- Easy operation and integration, saves time
- Maintenance-free sensor, reduces downtime
- Testing in place possible - no mounting required, which reduces installation time
- Flexible and tough system for a multitude of applications
- Solutions for vertically mounted switches in difficult installation conditions



Features

Medium:	Bulk solids
Measurement:	Switch
Probe length:	2,400 mm
Process pressure:	-1 bar ... 6 bar
Process temperature:	-40 °C ... 150 °C
ATEX certification:	-
Particle size:	< 10 mm
Fill material density:	0.008 g/cm ³
Tensile strength:	≤ 3,000 N

Performance

Accuracy:	± 10 mm
Repeatability:	± 5 mm
Response time:	500 ms

Mechanical data

Housing material:	Aluminum
Process connection:	G 1½ A PN 25/316L

Sensor material:

Stainless steel 316L, 318LN, PUR

Electrical data

Enclosure rating:	IP 66
Power consumption:	5 mA ... 30 mA
VDE protection class 1:	✓
Initialization time:	2 s
Output type:	Double relay (DPDT): 20 V DC ... 72 V DC/20 ... 253 V AC
Hysteresis:	10 mm
Output current:	> 10 UA, 3A AC, 1A DC
Capacitive load:	750 VA 54 W
Inductive load:	750 VA 54 W
Connection type:	½" NPT

Ambient data

Ambient operating temperature:	-40 °C ... 80 °C
Ambient storage temperature:	-40 °C ... 80 °C

Double relay connection diagram

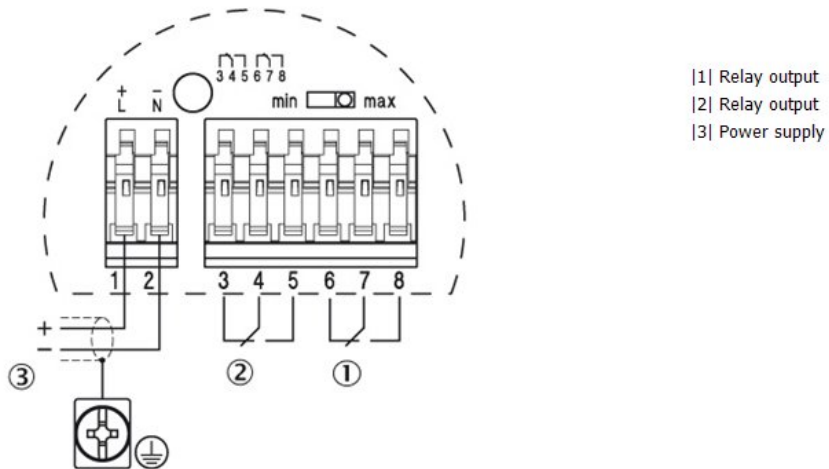

Flow orientation of the tuning fork



- |1| Marking with screwed version
- |2| Direction of flow

Mounting instruction: filling / emptying

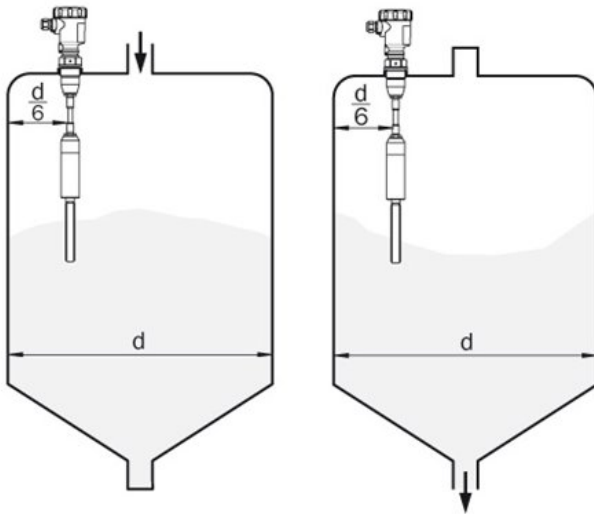

Mounting instruction: filling / emptying (side view)

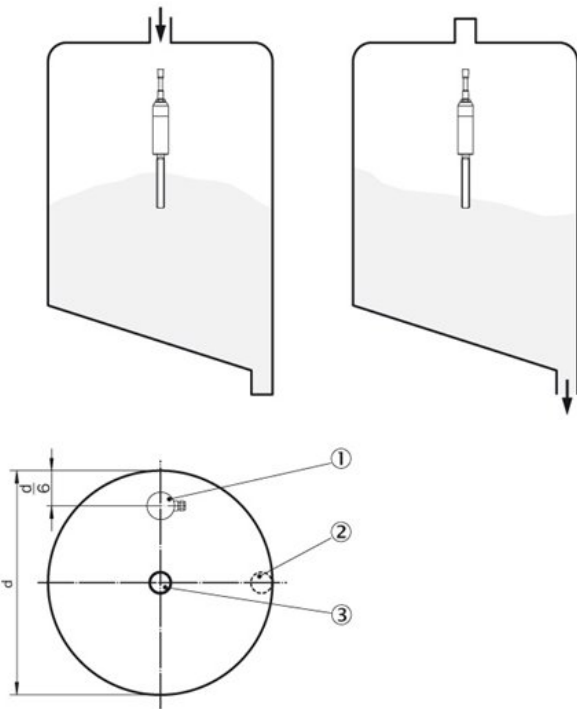

- |1| LBV320
- |2| Discharge opening
- |3| Filling opening

Horizontal mounting

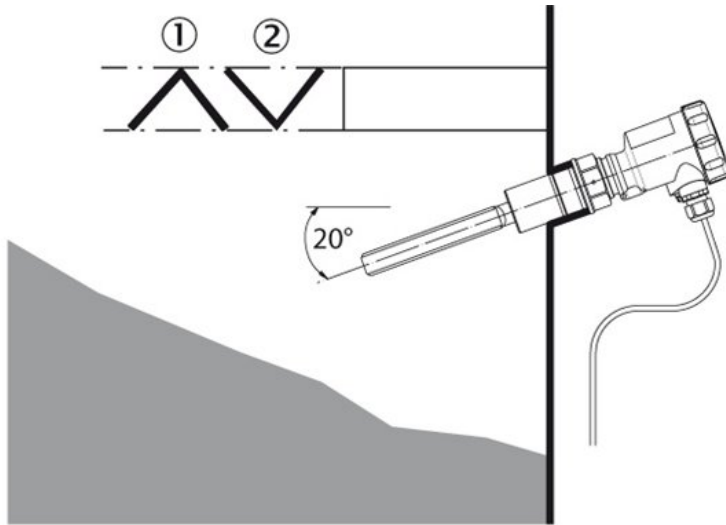

- |1| Protective sheet
- |2| Concave protective sheet for abrasive solids

Dimensional drawing

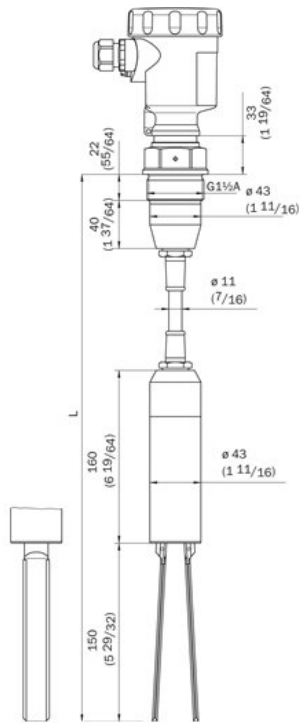

Australia

Phone +61 3 9457 0600
1800 334 802 – tollfree
E-Mail sales@sick.com.au

Belgium/Luxembourg

Phone +32 (0)2 466 55 66
E-Mail info@sick.be

Brasil

Phone +55 11 3215-4900
E-Mail sac@sick.com.br

Canada

Phone +1 905 771 14 44
E-Mail information@sick.com

Ceská Republika

Phone +420 2 57 91 18 50
E-Mail sick@sick.cz

China

Phone +86 4000 121 000
E-Mail info.china@sick.net.cn
Phone +852-2153 6300
E-Mail ghk@sick.com.hk

Danmark

Phone +45 45 82 64 00
E-Mail sick@sick.dk

Deutschland

Phone +49 211 5301-301
E-Mail kundenservice@sick.de

España

Phone +34 93 480 31 00
E-Mail info@sick.es

France

Phone +33 1 64 62 35 00
E-Mail info@sick.fr

Great Britain

Phone +44 (0)1727 831121
E-Mail info@sick.co.uk

India

Phone +91-22-4033 8333
E-Mail info@sick-india.com

Israel

Phone +972-4-6801000
E-Mail info@sick-sensors.com

Italia

Phone +39 02 27 43 41
E-Mail info@sick.it

Japan

Phone +81 (0)3 3358 1341
E-Mail support@sick.jp

Magyarország

Phone +36 1 371 2680
E-Mail office@sick.hu

Nederlands

Phone +31 (0)30 229 25 44
E-Mail info@sick.nl

Norge

Phone +47 67 81 50 00
E-Mail austefjord@sick.no

Österreich

Phone +43 (0)22 36 62 28 8-0
E-Mail office@sick.at

Polska

Phone +48 22 837 40 50
E-Mail info@sick.pl

România

Phone +40 356 171 120
E-Mail office@sick.ro

Russia

Phone +7-495-775-05-30
E-Mail info@sick.ru

Schweiz

Phone +41 41 619 29 39
E-Mail contact@sick.ch

Singapore

Phone +65 6744 3732
E-Mail admin@sicksgp.com.sg

Slovenija

Phone +386 (0)1-47 69 990
E-Mail office@sick.si

South Africa

Phone +27 11 472 3733
E-Mail info@sickautomation.co.za

South Korea

Phone +82 2 786 6321/4
E-Mail info@sickkorea.net

Suomi

Phone +358-9-25 15 800
E-Mail sick@sick.fi

Sverige

Phone +46 10 110 10 00
E-Mail info@sick.se

Taiwan

Phone +886-2-2375-6288
E-Mail sales@sick.com.tw

Türkiye

Phone +90 (216) 528 50 00
E-Mail info@sick.com.tr

United Arab Emirates

Phone +971 (0) 4 8865 878
E-Mail info@sick.ae

USA/México

Phone +1(952) 941-6780
1 800-325-7425 – tollfree
E-Mail info@sickusa.com

More representatives and agencies
at www.sick.com