



Pressure sensors  
Pressure switch

PBS-RB010SG1SSNBMA0Z



**Model Name** > **PBS-RB010SG1SSNBMA0Z**  
**Part No.** > **6038888**



*Product may differ from illustration*

**At a glance**

- Gauge measurement ranges from 0 ... 1 bar up to 0 ... 600 bar
- No moving parts: No mechanical wear, fatigue-proof, maintenance-free
- Stainless steel membrane
- Various programmable switching functions
- Digital outputs PNP or NPN, Analog output signal 4 ... 20 mA or 0 ... 10 V
- Min/max pressure memory
- Password protection
- Selection of different pressure units for the display
- IO-Link optional

**Your benefits**

- Compact size takes up less space
- Dual rotatable housing ensures flexible installation
- Quick and easy setup and operation due to three large buttons and bright display
- Wide range of applications
- Resistant against corrosive media due to circularly welded, hermetically sealed stainless steel membrane
- Available in a wide selection of configurations, enabling a perfect match to individual customer requirements
- IO-Link technology provides time and cost savings by enabling parameter adjustments, for example, upon product changeover to be performed remotely



**Features**

Pressure type:	Gauge pressure
Measuring range:	0 bar ... 10 bar
Process temperature:	-20 °C ... 85 °C
Rated temperature:	0 °C ... 80 °C
CE-conformity:	✓
Display:	14-segment-LED, blue, 4-digits, height 9 mm, electronically turnable by 180°, Update: 1000, 500, 200, 100 ms (adjustable), Accuracy: ≤ 1.0 % of span ± 1 digit
Output signal:	1x PNP + 4...20 mA

**Performance**

Accuracy:	≤ +/- 1 % (of span)
Non-linearity:	0.5 % (Best Fit Straight Line (BFSL))

## Mechanics/electronics

Process connection:	G 1/4 A (DIN 3852-E)
Wetted parts:	Pressure Connection: 316L, Pressure sensor: 316 L (for measurement ranges from 0 ... 10 bar rel: 13-8 PH)
Seal:	NBR
Housing material:	Display window: PC, Plastic head: PC + ABS, Buttons: TPE-E, Lower body: 316 L
Enclosure rating:	IP 67
Connection type:	Plug M12 x1, 4-pin
Supply voltage:	15 V DC ... 35 V DC
Power consumption:	100 mA
Electrical safety:	Short-circuit protection: QA, Q1, Q2 towards M, Protection class: III, Overvoltage protection: 40 V DC, Reverse polarity protection: L+ towards M
Protection class III:	✓

## Ambient data

Ambient temperature:	-20 °C ... 80 °C
Shock load:	50 g according to IEC 60068-2-27 (mechanical shock)
Vibration load:	10 g according to IEC 60068-2-6 (vibration under resonance)

## Dimensional drawing housing

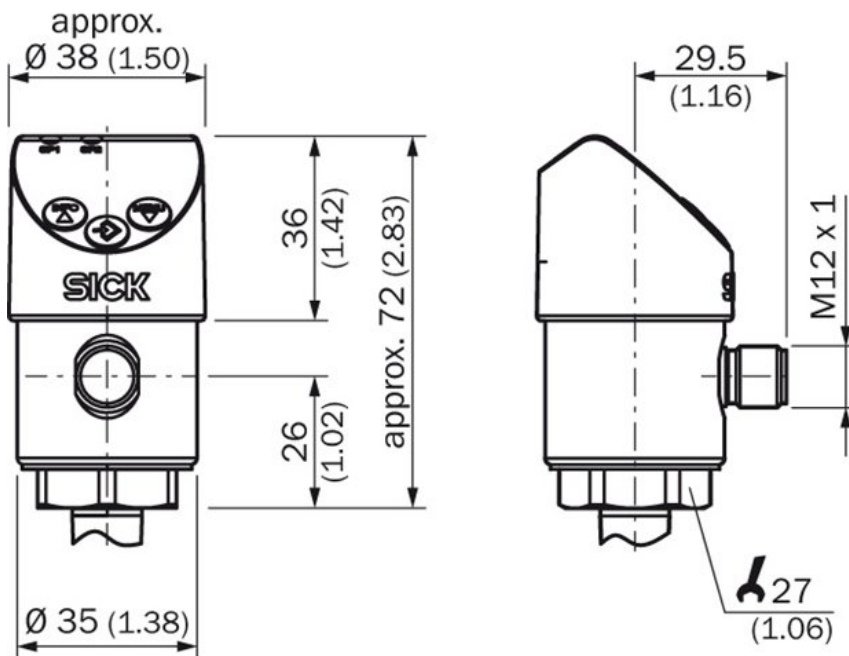

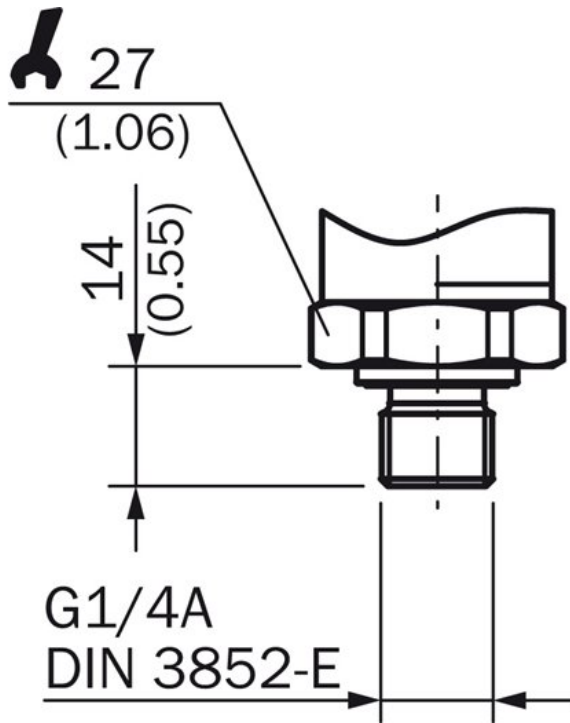

**Australia**

Phone +61 3 9457 0600  
1800 334 802 – tollfree  
E-Mail sales@sick.com.au

**Belgium/Luxembourg**

Phone +32 (0)2 466 55 66  
E-Mail info@sick.be

**Brasil**

Phone +55 11 3215-4900  
E-Mail sac@sick.com.br

**Canada**

Phone +1 905 771 14 44  
E-Mail information@sick.com

**Ceská Republika**

Phone +420 2 57 91 18 50  
E-Mail sick@sick.cz

**China**

Phone +86 4000 121 000  
E-Mail info.china@sick.net.cn  
Phone +852-2153 6300  
E-Mail ghk@sick.com.hk

**Danmark**

Phone +45 45 82 64 00  
E-Mail sick@sick.dk

**Deutschland**

Phone +49 211 5301-301  
E-Mail kundenservice@sick.de

**España**

Phone +34 93 480 31 00  
E-Mail info@sick.es

**France**

Phone +33 1 64 62 35 00  
E-Mail info@sick.fr

**Great Britain**

Phone +44 (0)1727 831121  
E-Mail info@sick.co.uk

**India**

Phone +91-22-4033 8333  
E-Mail info@sick-india.com

**Israel**

Phone +972-4-6801000  
E-Mail info@sick-sensors.com

**Italia**

Phone +39 02 27 43 41  
E-Mail info@sick.it

**Japan**

Phone +81 (0)3 3358 1341  
E-Mail support@sick.jp

**Magyarország**

Phone +36 1 371 2680  
E-Mail office@sick.hu

**Nederlands**

Phone +31 (0)30 229 25 44  
E-Mail info@sick.nl

**Norge**

Phone +47 67 81 50 00  
E-Mail austefjord@sick.no

**Österreich**

Phone +43 (0)22 36 62 28 8-0  
E-Mail office@sick.at

**Polska**

Phone +48 22 837 40 50  
E-Mail info@sick.pl

**România**

Phone +40 356 171 120  
E-Mail office@sick.ro

**Russia**

Phone +7-495-775-05-30  
E-Mail info@sick.ru

**Schweiz**

Phone +41 41 619 29 39  
E-Mail contact@sick.ch

**Singapore**

Phone +65 6744 3732  
E-Mail admin@sicksgp.com.sg

**Slovenija**

Phone +386 (0)1-47 69 990  
E-Mail office@sick.si

**South Africa**

Phone +27 11 472 3733  
E-Mail info@sickautomation.co.za

**South Korea**

Phone +82 2 786 6321/4  
E-Mail info@sickkorea.net

**Suomi**

Phone +358-9-25 15 800  
E-Mail sick@sick.fi

**Sverige**

Phone +46 10 110 10 00  
E-Mail info@sick.se

**Taiwan**

Phone +886-2-2375-6288  
E-Mail sales@sick.com.tw

**Türkiye**

Phone +90 (216) 528 50 00  
E-Mail info@sick.com.tr

**United Arab Emirates**

Phone +971 (0) 4 8865 878  
E-Mail info@sick.ae

**USA/México**

Phone +1(952) 941-6780  
1 800-325-7425 – tollfree  
E-Mail info@sickusa.com

More representatives and agencies  
at [www.sick.com](http://www.sick.com)