



Absolute encoders AFS/AFM60 PROFINET

AFM60A-S4NB Sales-Kit 03



Model Name > [AFM60A-S4NB Sales-Kit 03](#)
Part No. > [1059385](#)



Illustration may differ

This kit includes the following items:

Model Name	Part No.
> AFM60A-S4NB018X12	> 1059039
> DOS-1204-W	> 6007303
> STE-1204-WZ	> 6048262

At a glance

- High-resolution 30-bit absolute encoder (18-bit singleturn and 12-bit multiturn)
- Face mount flange, servo flange and blind hollow shaft
- Connection type: 3 x M12 axial plug
- PROFINET-IO-RT interface
- Less than 5 ms data update time
- Round axis functionality
- Alarms, warnings and diagnostics functions for speed, position, temperature, operating time, etc.
- Status display via 5 LEDs

Your benefits

- Increased productivity as a result of intelligent diagnostics functions and rapid data transfer
- Increase in network reliability due to early error detection
- Simple installation with various configuration options
- Flexible, easy setup and high resolutions for various applications with binary, integer and "decimal point" values based on round axis functionality
- Maximum system availability through embedded switch technology
- Compact and cost-efficient design



Performance

Max. number of steps per revolution:	262,144
Max. number of revolutions:	4,096
Resolution power:	262,144 x 4,096
Resolution:	18 bit x 12 bit
Error limits:	≤ 0.03 °
Repeatability (Ta not constant):	≤ 0.002 °
Measuring step deviation:	± 0.002 °
Initialization time:	6 s

Mechanical data

Mechanical interface:	Solid shaft with flat
Shaft diameter:	10 mm
Mass:	0.2 kg
Start up torque:	0.5 Ncm (20 °C)
Operating torque:	0.3 Ncm (20 °C)
Permissible Load capacity of shaft:	40 N (axial), 80 N (radial)
Maximum operating speed:	9,000 Hz ¹⁾
Moment of inertia of the rotor:	6.2 gcm ²
Bearing lifetime:	3.0 x 10 ⁹ revolutions
Max. angular acceleration:	500,000 rad/s ²
Shaft material:	Stainless steel
Flange material:	Aluminum

¹⁾ Self warming of 3.3 K per 1000 revolutions/min when applying note working temperature range

Electrical data

Operating voltage range:	10 V DC ... 30 V DC
MTTFd: mean time to dangerous failure:	80 a (EN ISO 13849-1) ¹⁾

¹⁾ This product is a standard product and does not constitute a safety component as defined in the Machinery Directive.

Calculation based on nominal load of components, average ambient temperature 40°C, frequency of use 8760 h/a. All

electronic failures are considered hazardous. For more information, see document no. 8015532.

Interfaces

Electrical interface:	3 x connector M12, 4-pin, axial
Bus interface:	PROFINET IO/ RT Class B
Data transmission rate (baud rate):	10 Mbit/s/100 Mbit/s
Encoder profile:	V4.1 class3
RPI (requested packet interval):	2 ms ... 750 ms
DLR (Device Level Ring):	0
Endless operating functionality:	0

Ambient data

EMC:	(according to EN 61000-6-2 and EN 61000-6-3) ¹⁾
Enclosure rating:	IP 65 (according to IEC 60529), shaft side, IP 67 (according to IEC 60529)
Permissible relative humidity:	90 % (condensation of the optical scanning not permitted)
Working temperature range:	-30 °C ... 85 °C
Storage temperature range:	-40 °C ... 100 °C, without package
Resistance to shocks:	100 g (according to EN 60068-2-27)
Resistance to vibration:	30 g, 10 Hz ... 2,000 Hz (according to EN 60068-2-6)

¹⁾ The EMC according to the standards quoted is achieved if screened cables are used. ²⁾ With mating connector fitted

Dimensional drawing

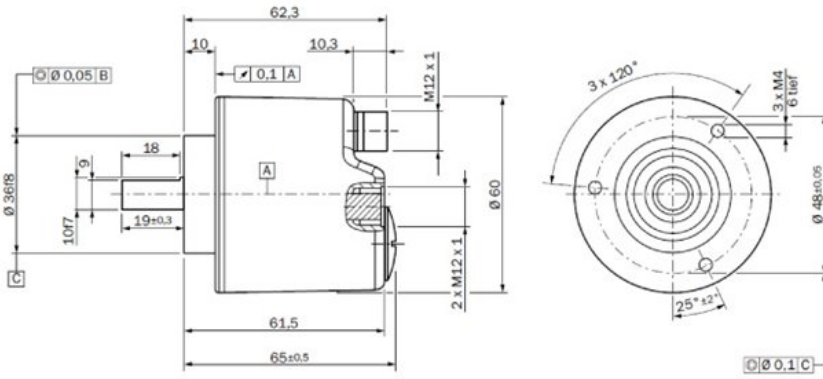

PIN assignment

Image Unavailable
f:\Saqqara\im0050501.jpg

Australia

Phone +61 3 9457 0600
1800 334 802 – tollfree
E-Mail sales@sick.com.au

Belgium/Luxembourg

Phone +32 (0)2 466 55 66
E-Mail info@sick.be

Brasil

Phone +55 11 3215-4900
E-Mail sac@sick.com.br

Canada

Phone +1 905 771 14 44
E-Mail information@sick.com

Ceská Republika

Phone +420 2 57 91 18 50
E-Mail sick@sick.cz

China

Phone +86 4000 121 000
E-Mail info.china@sick.net.cn
Phone +852-2153 6300
E-Mail ghk@sick.com.hk

Danmark

Phone +45 45 82 64 00
E-Mail sick@sick.dk

Deutschland

Phone +49 211 5301-301
E-Mail kundenservice@sick.de

España

Phone +34 93 480 31 00
E-Mail info@sick.es

France

Phone +33 1 64 62 35 00
E-Mail info@sick.fr

Great Britain

Phone +44 (0)1727 831121
E-Mail info@sick.co.uk

India

Phone +91-22-4033 8333
E-Mail info@sick-india.com

Israel

Phone +972-4-6801000
E-Mail info@sick-sensors.com

Italia

Phone +39 02 27 43 41
E-Mail info@sick.it

Japan

Phone +81 (0)3 3358 1341
E-Mail support@sick.jp

Magyarország

Phone +36 1 371 2680
E-Mail office@sick.hu

Nederlands

Phone +31 (0)30 229 25 44
E-Mail info@sick.nl

Norge

Phone +47 67 81 50 00
E-Mail austefjord@sick.no

Österreich

Phone +43 (0)22 36 62 28 8-0
E-Mail office@sick.at

Polska

Phone +48 22 837 40 50
E-Mail info@sick.pl

România

Phone +40 356 171 120
E-Mail office@sick.ro

Russia

Phone +7-495-775-05-30
E-Mail info@sick.ru

Schweiz

Phone +41 41 619 29 39
E-Mail contact@sick.ch

Singapore

Phone +65 6744 3732
E-Mail admin@sicksgp.com.sg

Slovenija

Phone +386 (0)1-47 69 990
E-Mail office@sick.si

South Africa

Phone +27 11 472 3733
E-Mail info@sickautomation.co.za

South Korea

Phone +82 2 786 6321/4
E-Mail info@sickkorea.net

Suomi

Phone +358-9-25 15 800
E-Mail sick@sick.fi

Sverige

Phone +46 10 110 10 00
E-Mail info@sick.se

Taiwan

Phone +886-2-2375-6288
E-Mail sales@sick.com.tw

Türkiye

Phone +90 (216) 528 50 00
E-Mail info@sick.com.tr

United Arab Emirates

Phone +971 (0) 4 8865 878
E-Mail info@sick.ae

USA/México

Phone +1(952) 941-6780
1 800-325-7425 – tollfree
E-Mail info@sickusa.com

More representatives and agencies
at www.sick.com